

SECTION - 13

INTESTINAL AND RECTAL



INTESTINAL & RECTAL

PEARLITE SURGICAL INSTRUMENTS
IN FINEST GRADE STAINLESS STEEL MADE

PLS

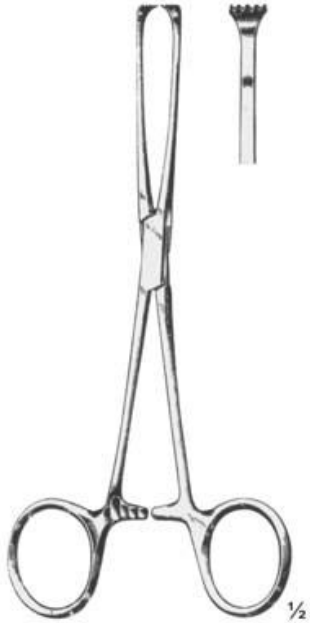

ALLIS
13-001-150
15 cm
3 x 3 teeth
4 x 5 teeth
5 x 6 teeth



JUDD-ALLIS 3:4
13-002-150 15.0 cm
13-003-190 19.0 cm



LOCKWOOD
13-004-200
20 cm

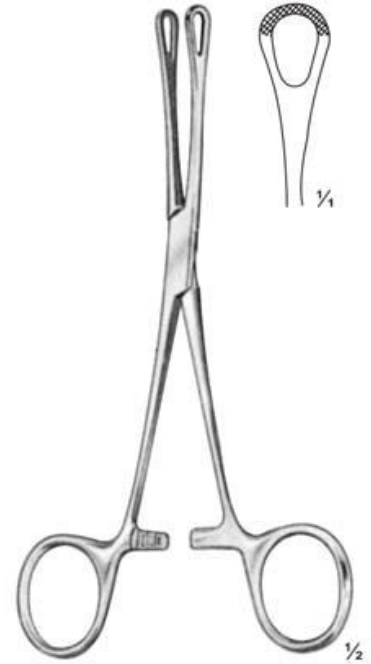

WILLIAMS
13-005-160
16 cm



BABCOCK
13-006-160 16 cm 8 mm
13-007-180 18 cm 10 mm
13-008-200 20 cm 13 mm



LANE
13-009-150 15 cm
13-010-180 18 cm
13-011-200 20 cm



LITTLE WOOD
13-012-190
19 cm, Box Joint,

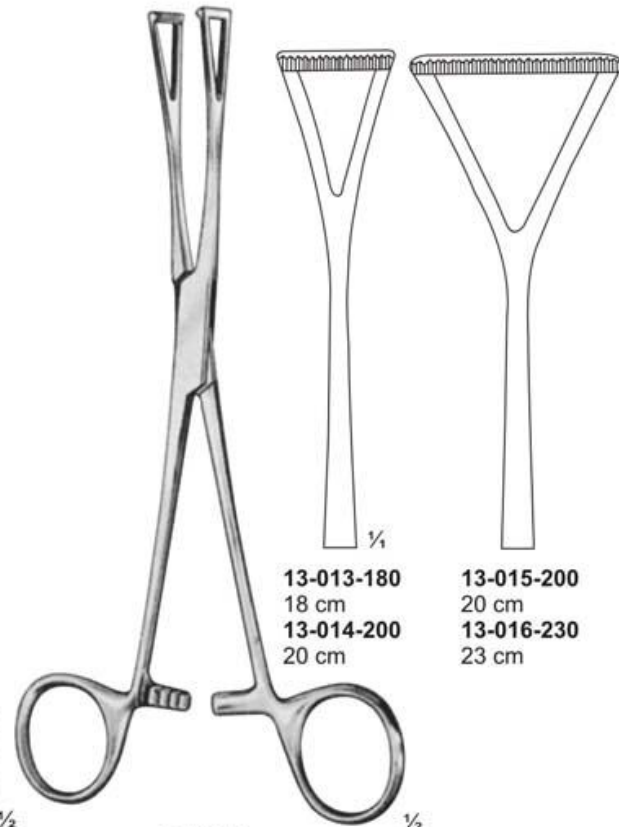

DUVAL

13-013-180
18 cm
13-014-200
20 cm

13-015-200
20 cm
13-016-230
23 cm

INTESTINAL & RECTAL

PEARLITE SURGICAL INSTRUMENTS
IN FINEST GRADE STAINLESS STEEL MADE

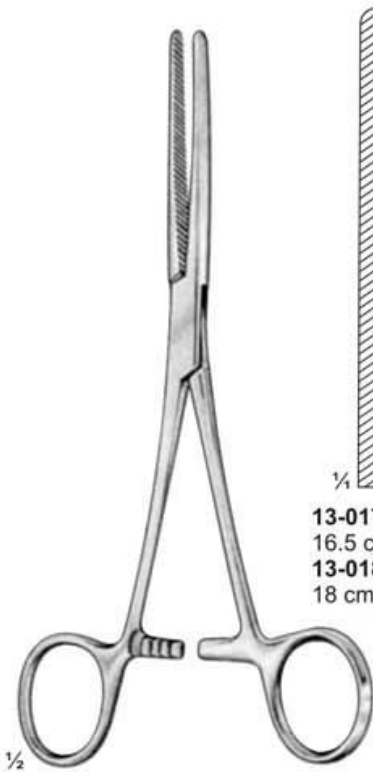

13-017-165
16.5 cm
13-018-180
18 cm

BABY-DOYEN

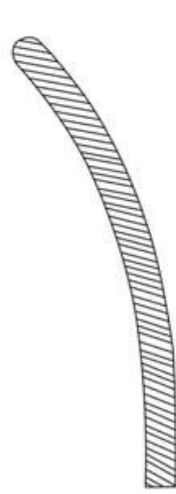

13-019-165
16.5 cm
13-020-180
18 cm



MAYO-ROBSON



13-021-210
21 cm
13-022-230
23 cm
13-023-250
25 cm

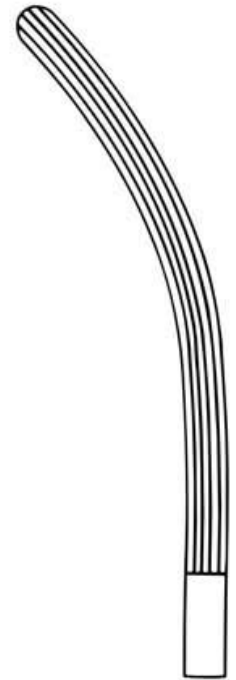

13-024-210
21 cm
13-025-230
23 cm
13-026-250
25 cm

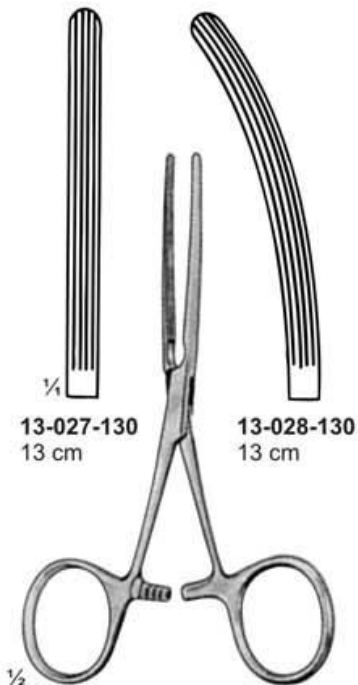

BABY-KOCHER

13-027-130
13 cm

13-028-130
13 cm



KOCHER



13-029-220
22 cm
Straight



DOYEN

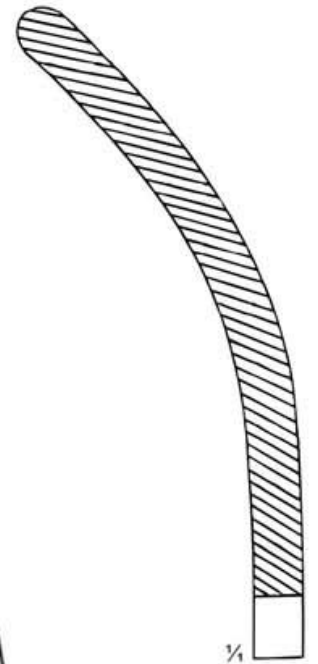

13-030-220
22 cm
Curved, grooved

INTESTINAL & RECTAL

PEARLITE SURGICAL INSTRUMENTS
IN FINEST GRADE STAINLESS STEEL MADE

PLS



13-031-220
22 cm
Straight



13-032-250
25 cm
Straight



13-033-280
28 cm
Straight



KOCHER



13-034-220
22 cm
Curved



13-035-250
25 cm
Curved



13-036-280
28 cm
Curved



BRUNNER
13-037-240
24.0 cm

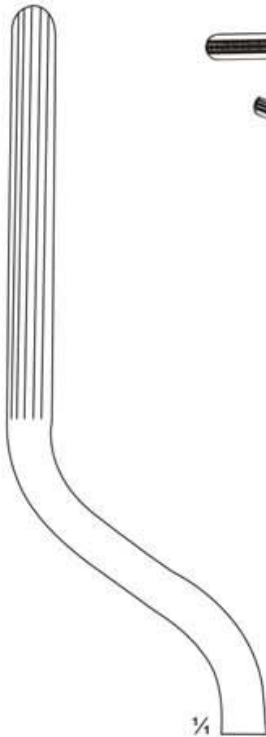

RESANO
13-038-300
30.0 cm



FEHLAND
13-039-240
24.0 cm

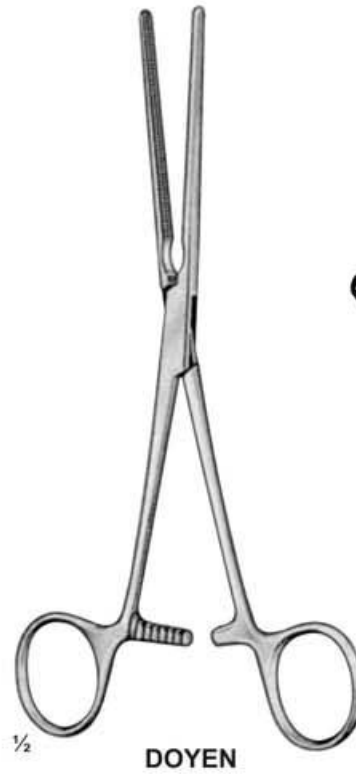
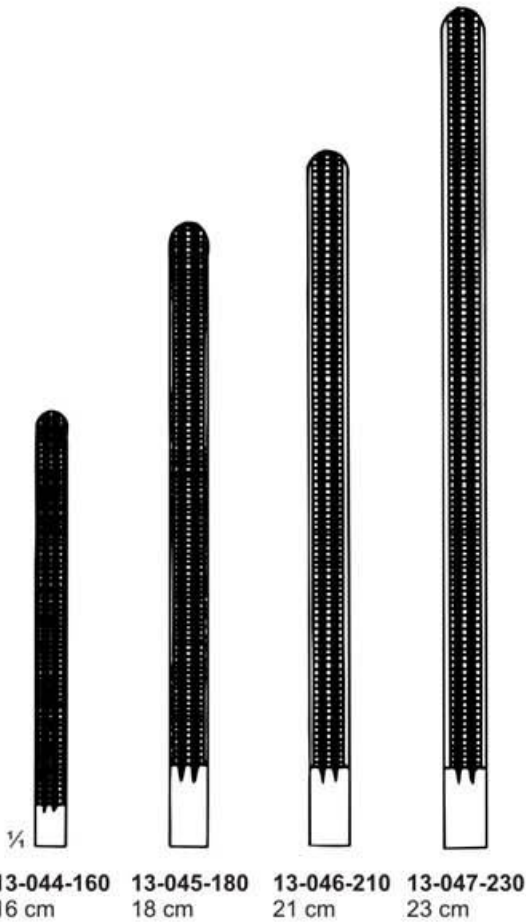
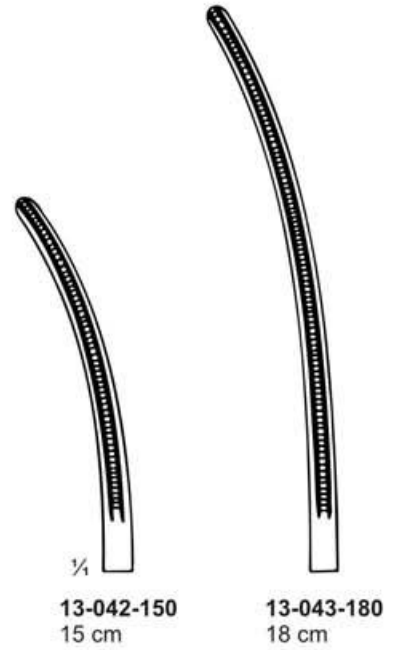
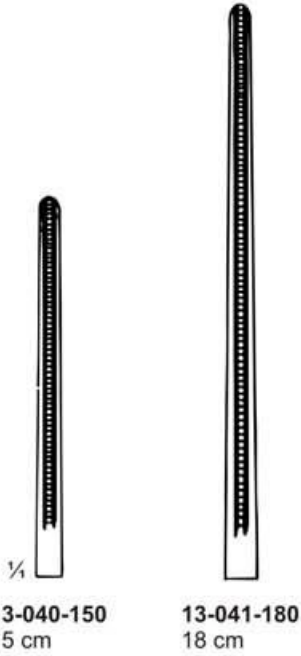

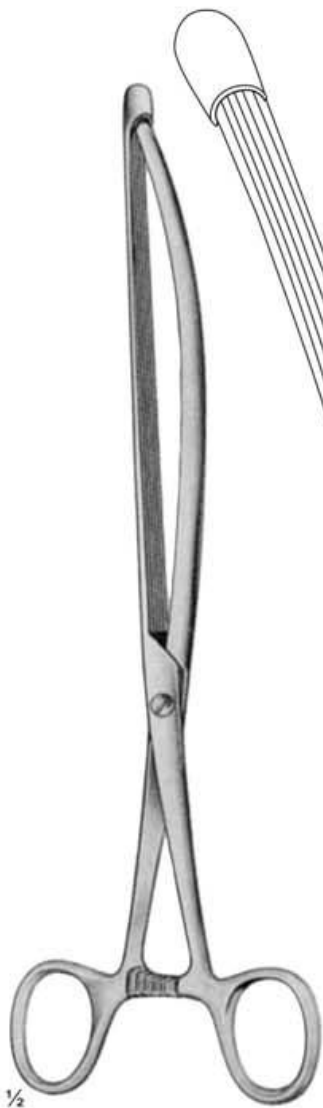

NUSSBAUM

13-052-250
25 cm

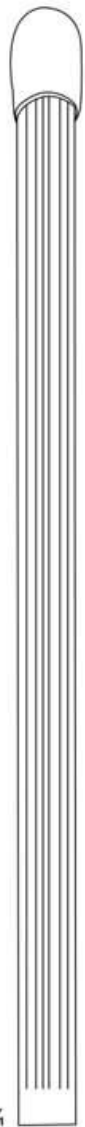

13-053-250
25 cm



SCUDDER

13-054-250
25 cm
13-055-330
33 cm

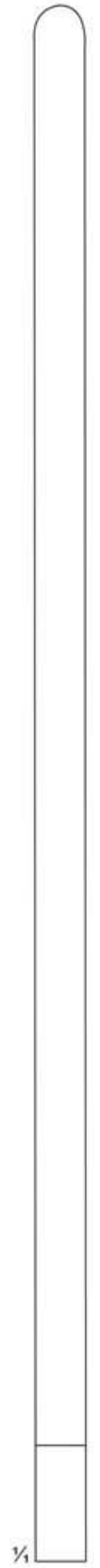

13-056-250
25 cm
13-057-330
33 cm

INTESTINAL & RECTAL

PEARLITE SURGICAL INSTRUMENTS
IN FINEST GRADE STAINLESS STEEL MADE



LANE Str.
13-058-300
30 cm



LANE Cvd.
13-059-300
30 cm

INTESTINAL & RECTAL

PEARLITE SURGICAL INSTRUMENTS
IN FINEST GRADE STAINLESS STEEL MADE **PLS**



PAYR-BABY
13-060-150
15.0 cm
without pin
13-061-150
15.0 cm
with pin

PAYR
13-062-210
21.0 cm
without pin
13-063-210
21.0 cm
with pin

PAYR
13-064-290
29 cm
without pin
13-065-290
29 cm
with pin

PAYR
13-066-350
35 cm
without pin
13-067-350
35 cm
with pin

INTESTINAL & RECTAL

PEARLITE SURGICAL INSTRUMENTS
IN FINEST GRADE STAINLESS STEEL MADE

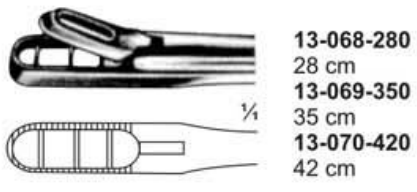
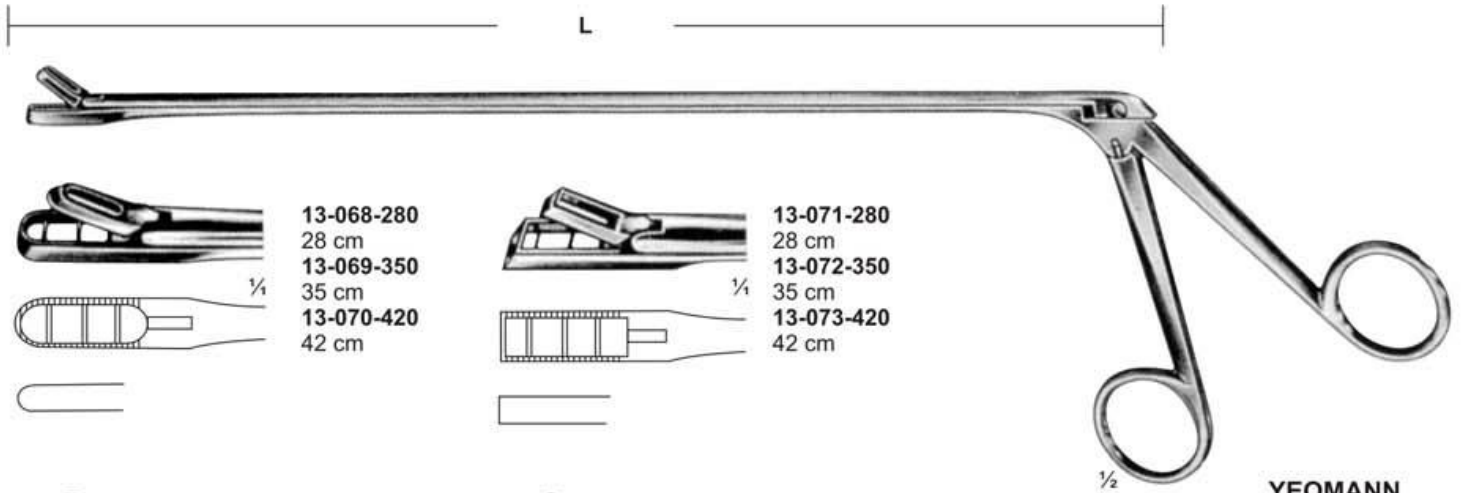

13-068-280
28 cm
13-069-350
35 cm
13-070-420
42 cm

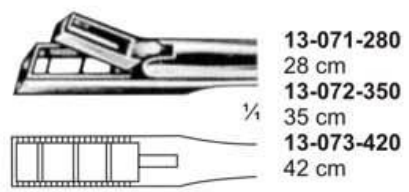

13-071-280
28 cm
13-072-350
35 cm
13-073-420
42 cm

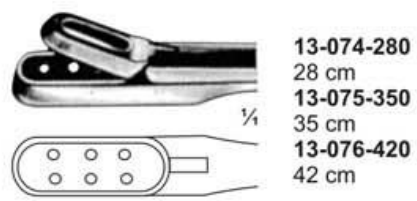

13-074-280
28 cm
13-075-350
35 cm
13-076-420
42 cm

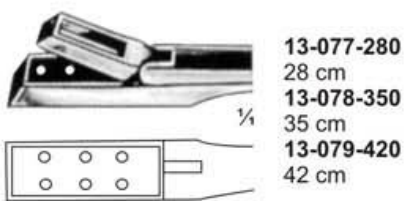

13-077-280
28 cm
13-078-350
35 cm
13-079-420
42 cm

YEOMANN

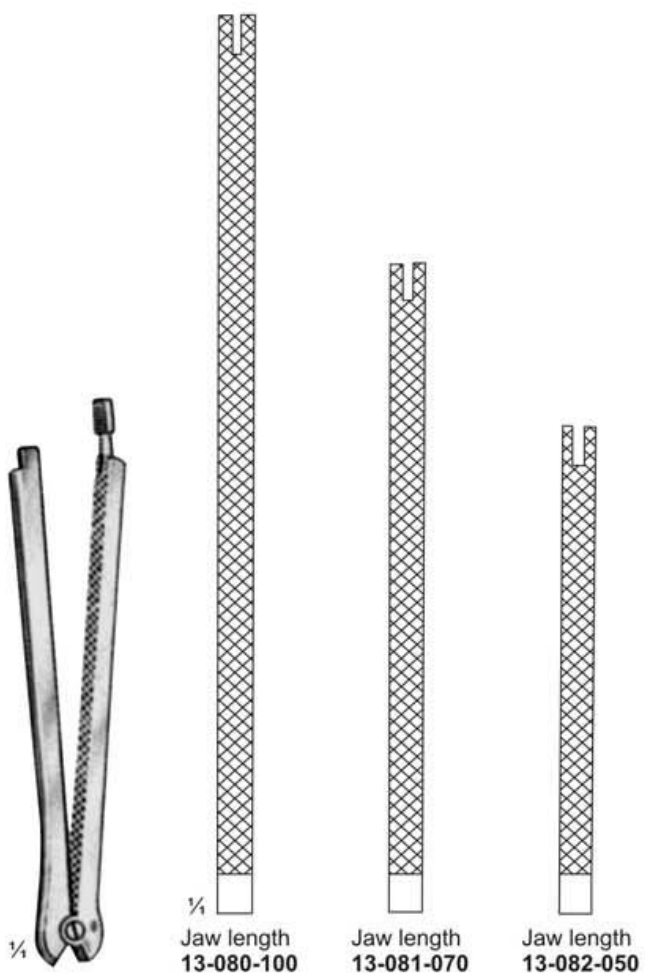

DE MARTEL-WOLFSON
set of 3
anastomosis clamps

Jaw length
13-080-100
10 cm

Jaw length
13-081-070
7 cm

Jaw length
13-082-050
5 cm

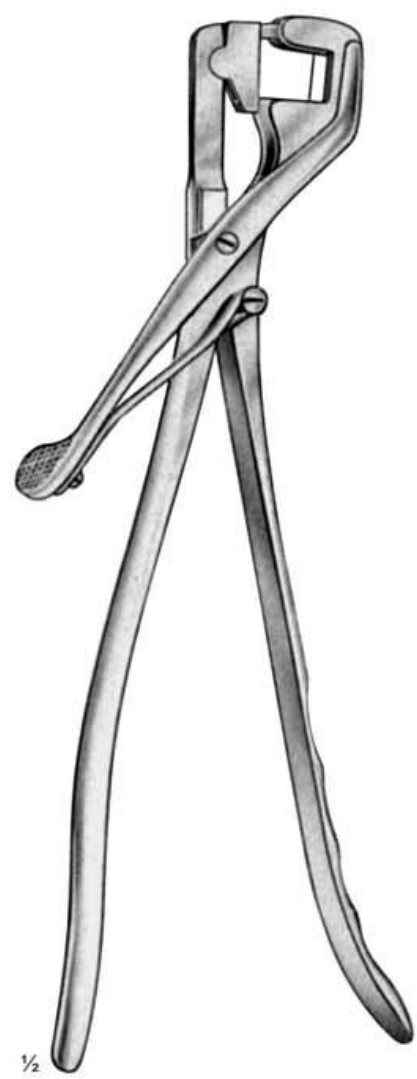

DE MARTEL-WOLFSON
13-083-260
26.0 cm

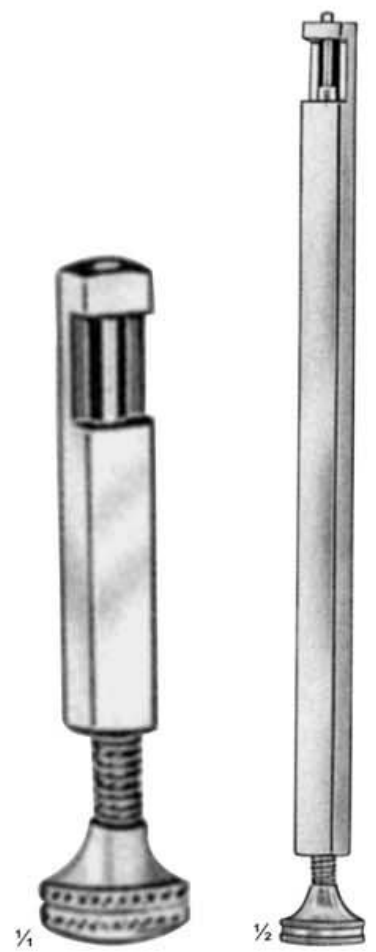

13-084-085
8.5 cm

DE MARTEL-WOLFSON
13-085-230
23 cm



1/2

MATHIEU
13-086-195
19.5 cm
90 x 15 mm



1/2

SIMS
13-087-150
15.0 cm



1/2

SIMS
13-088-150
15.0 cm



1/4

IVES-FANSLER
13-089-080
8 cm
80 x 22 mm



1/3

PRATT
13-090-215
21.5 cm
85 x 25 mm blade

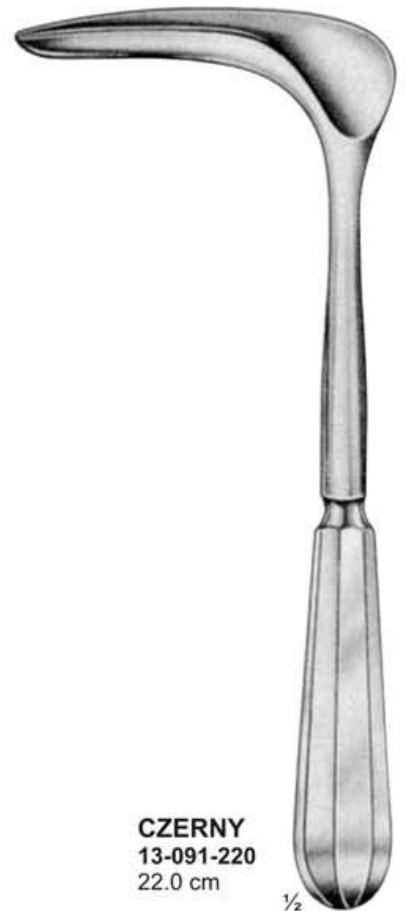

1/2

CZERNY
13-091-220
22.0 cm



13-092-00
16 ø x 65 mm
13-093-00
19 ø x 65 mm
13-094-00
22 ø x 65 mm
13-095-00
22 ø x 125 mm

HIRSCHMANN

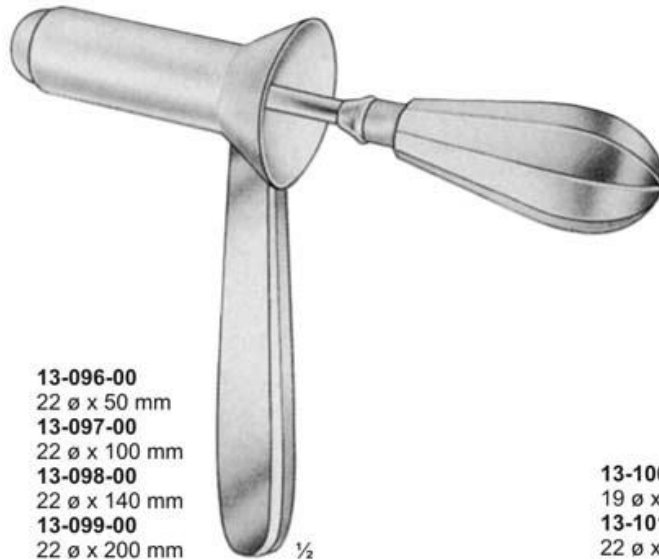

13-096-00
22 ø x 50 mm
13-097-00
22 ø x 100 mm
13-098-00
22 ø x 140 mm
13-099-00
22 ø x 200 mm

KELLY



13-100-00
19 ø x 70 mm
13-101-00
22 ø x 70 mm

BENSAUDE



13-102-150
15 cm
75 x 23 mm

SMITH-BLUE

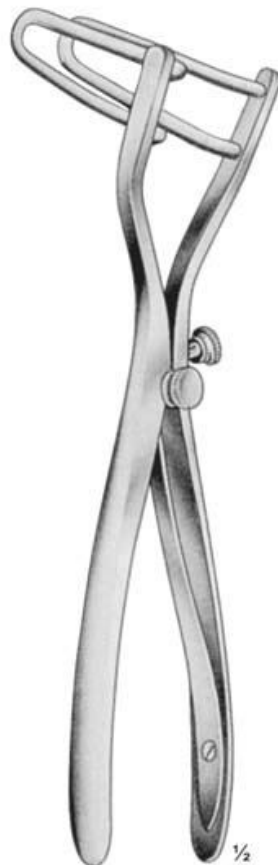

SCHULZE-BERGMANN

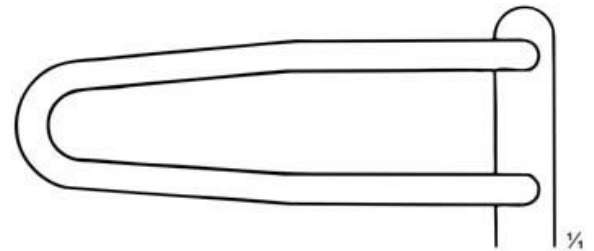

13-103-220 22 cm
60 mm
13-104-220 22 cm
80 mm
13-105-220 22 cm
125 mm
13-106-220 22 cm
150 mm

INTESTINAL & RECTAL T.C

PEARLITE SURGICAL INSTRUMENTS
IN FINEST GRADE STAINLESS STEEL MADE

PLS



ALLIS
13-107-150 15 cm
13-108-200 20 cm
13-109-220 22 cm
13-110-250 25 cm
13-111-300 30 cm

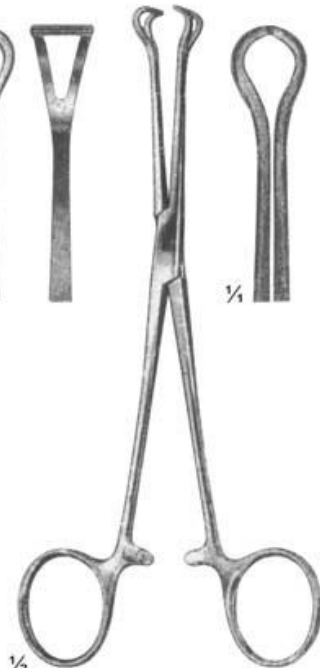

BABCOCK
13-112-160 16 cm
13-113-215 21.5 cm



DUVAL
13-114-250 25 cm
13-115-270 27 cm



BABCOCK



13-116-165 16.5 cm
13-117-203 20.3 cm



13-118-175 17.5 cm

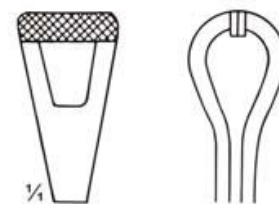

13-119-195 19.5 cm



13-120-130 13 cm

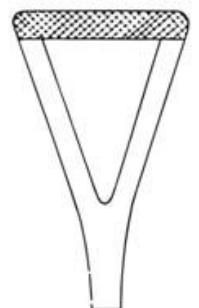

13-121-180 18 cm



DUVAL