

SECTION - 11

NEUROSURGERY

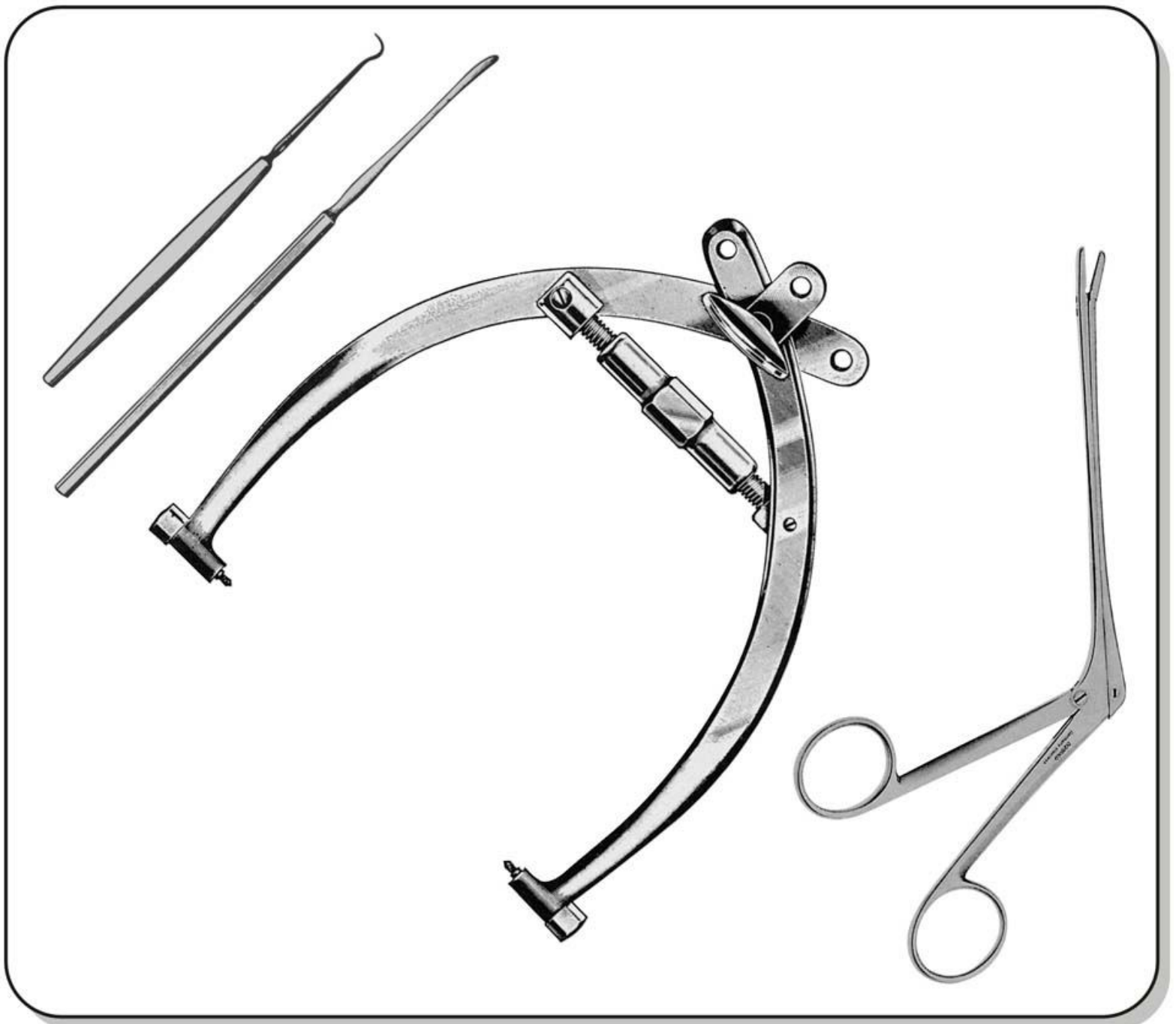

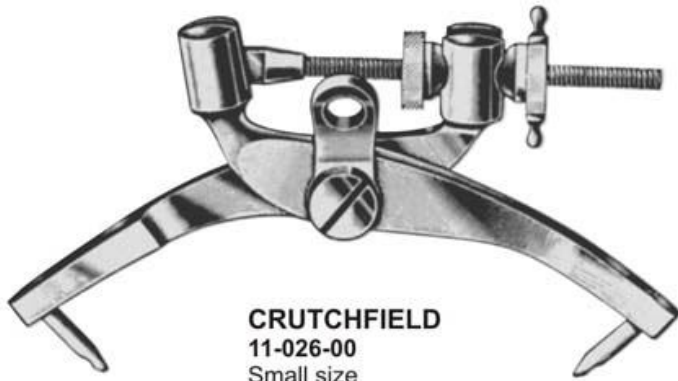

CRUTCHFIELD
11-026-00
Small size

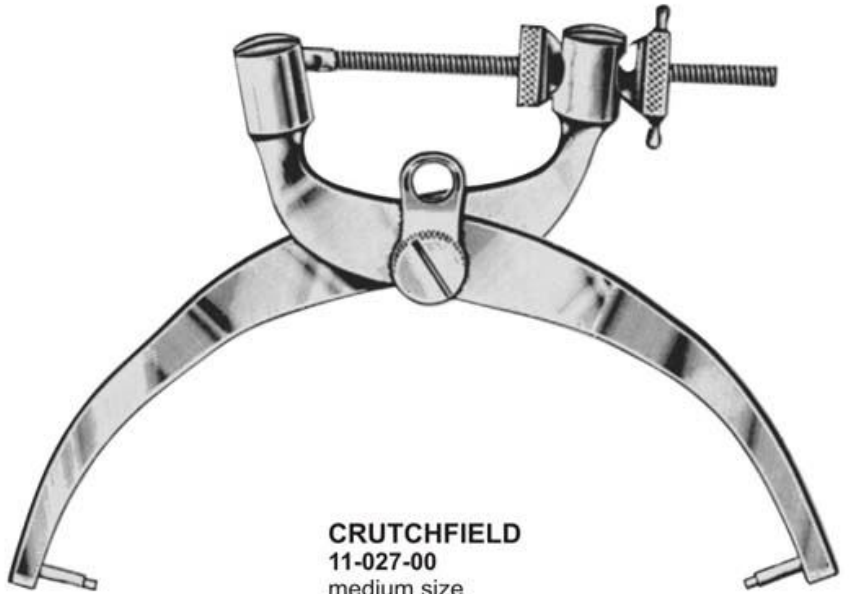

CRUTCHFIELD
11-027-00
medium size



11-028-00 Drill points
11-029-00



CRUTCHFIELD
11-030-00
Large size

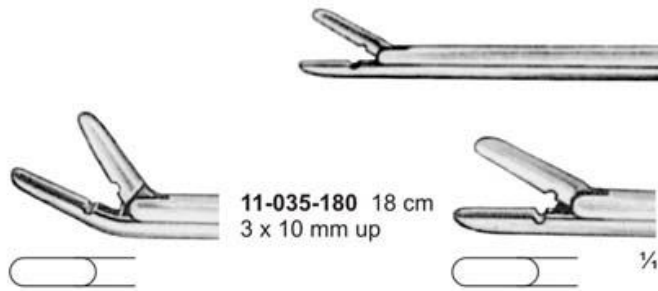
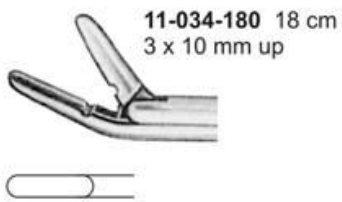
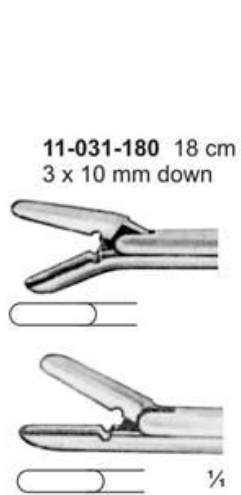

11-037-200 20 cm
3 x 10 mm

11-038-250 25 cm
3 x 10 mm Straight

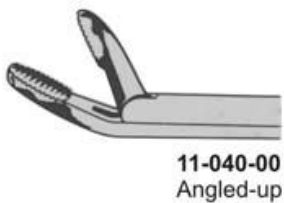
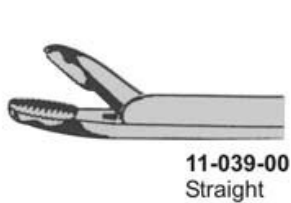
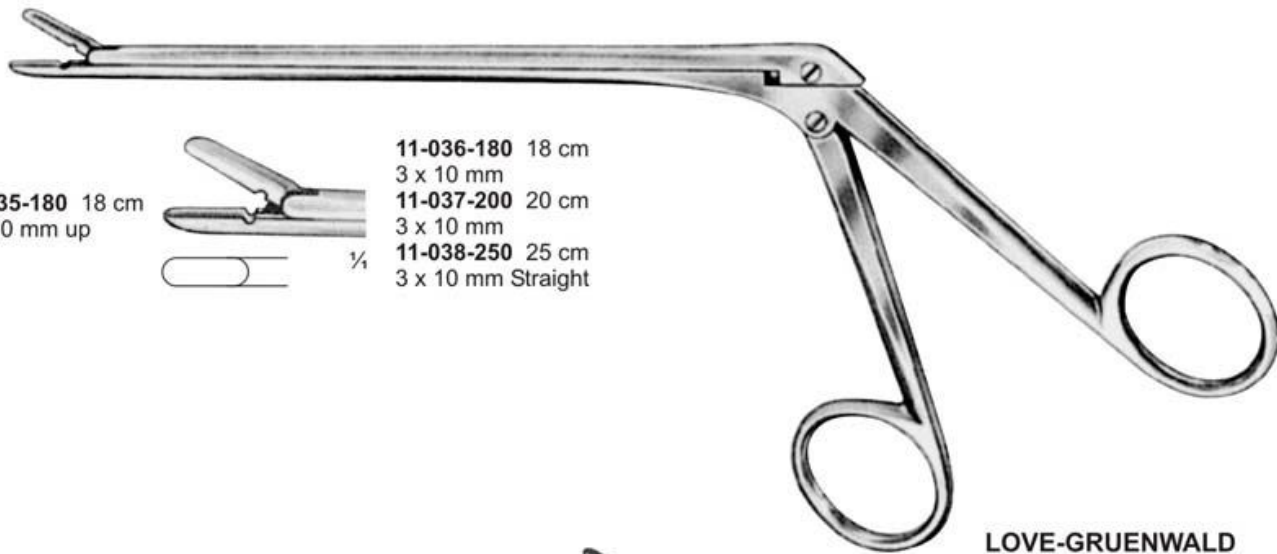

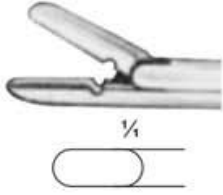
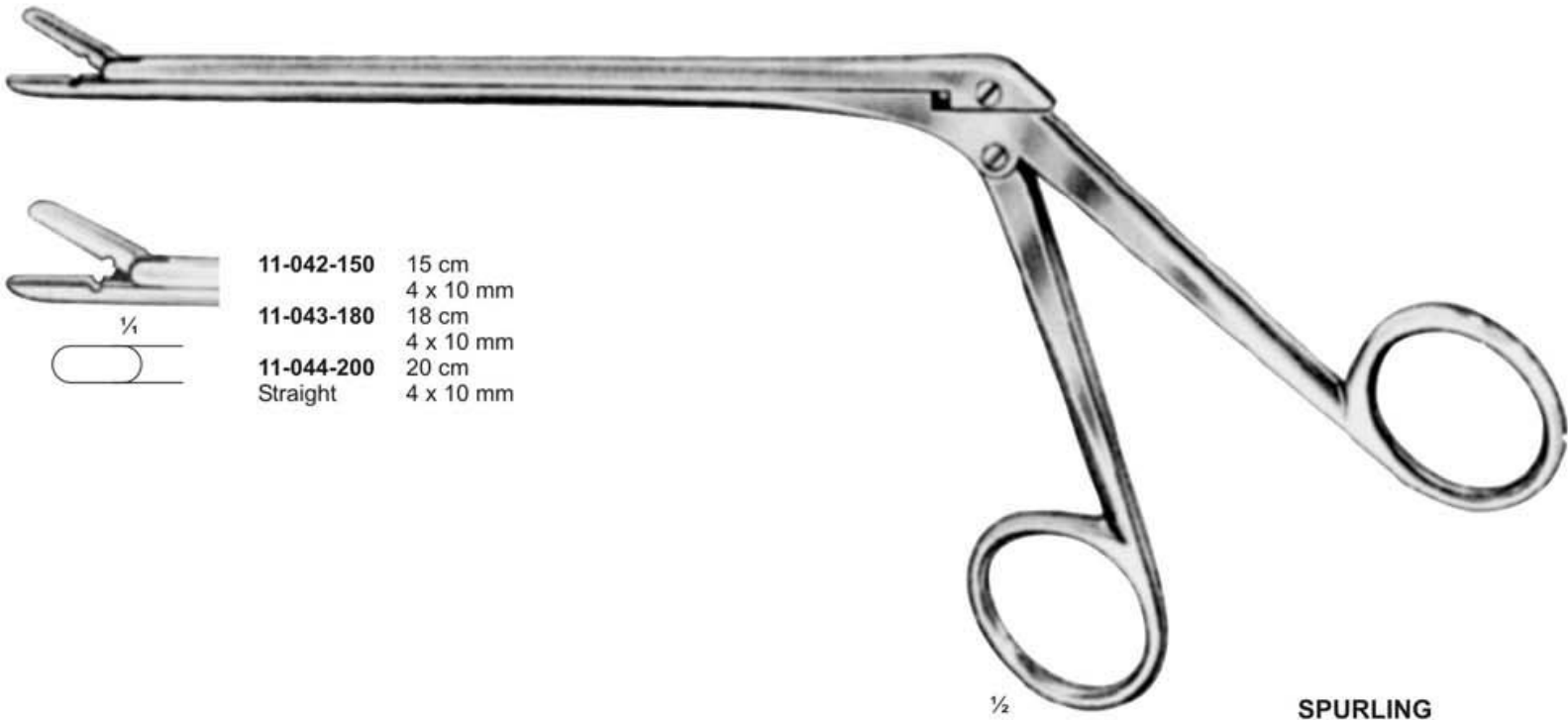

- 11-042-150** 15 cm
4 x 10 mm
- 11-043-180** 18 cm
4 x 10 mm
- 11-044-200** 20 cm
Straight 4 x 10 mm

1/2

SPURLING

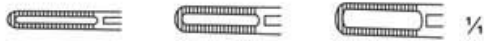
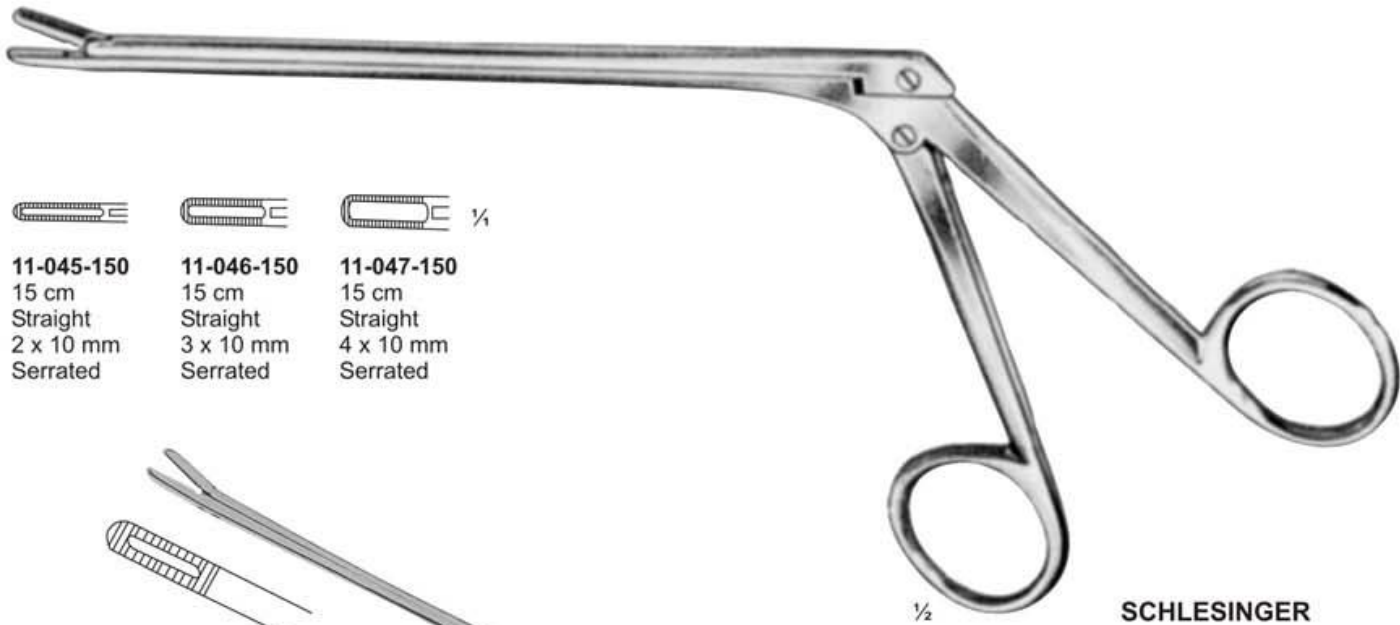

- 11-045-150** 15 cm
Straight
2 x 10 mm
Serrated
- 11-046-150** 15 cm
Straight
3 x 10 mm
Serrated
- 11-047-150** 15 cm
Straight
4 x 10 mm
Serrated

1/2

SCHLESINGER

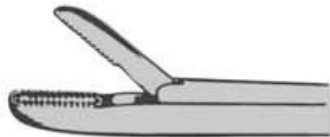

Straight

Shaft	130 mm	180 mm
Bite 2 x 10 mm	11-048-00	11-051-00
Bite 3 x 10 mm	11-049-00	11-052-00
Bite 4 x 10 mm	11-050-00	11-053-00



SCHLESINGER

 2.0 mm
  3.0 mm
  3.5 mm



90°
 Up-cutting
 Shaft 140 mm
 Bite 2.0 mm **11-054-00**
 Bite 3.0 mm **11-055-00**
 Bite 3.5 mm **11-056-00**



90°
 Down-cutting
 Shaft 140 mm
 Bite 2.0 mm **11-057-00**
 Bite 3.0 mm **11-058-00**
 Bite 3.5 mm **11-059-00**

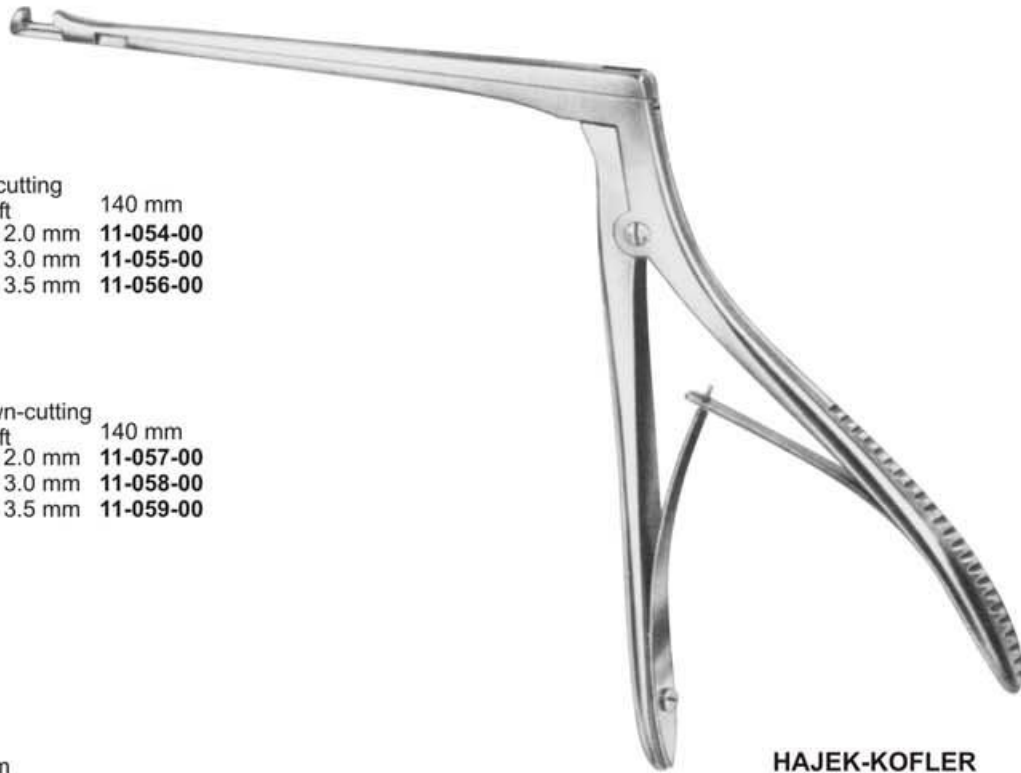

HAJEK-KOFLER

Shaft 140 mm

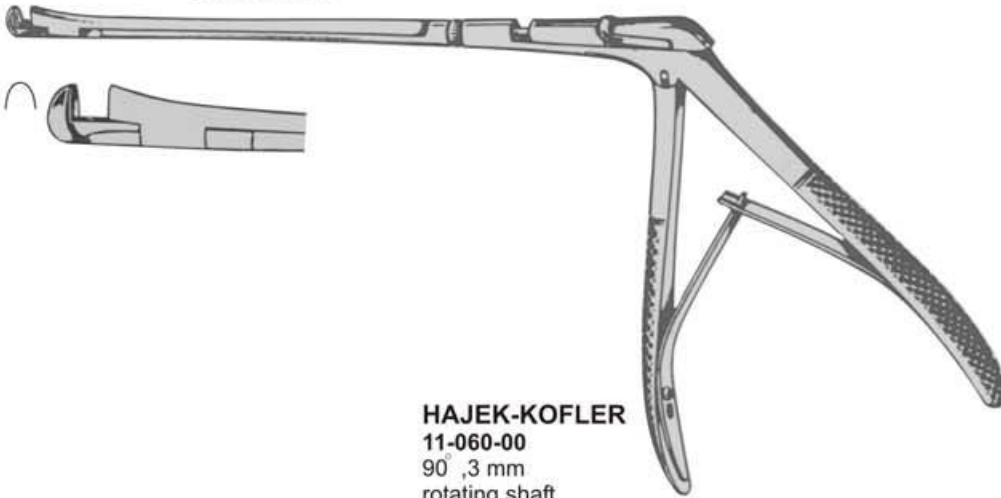

HAJEK-KOFLER
11-060-00
 90°, 3 mm
 rotating shaft

 1.0 mm
 2.5 mm
 4.0 mm

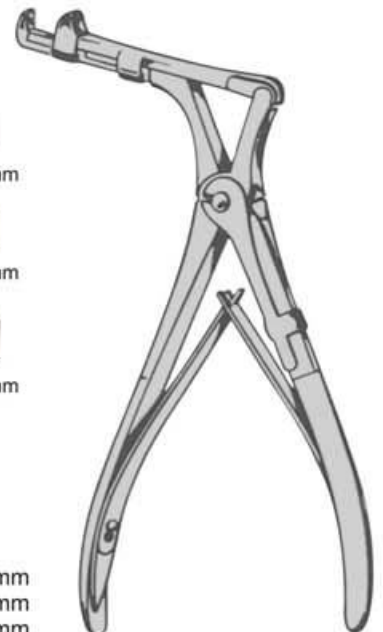

CITELLI
11-061-00 1.0 mm
11-062-00 2.5 mm
11-063-00 4.0 mm



**LOVE-KERRISON
LAMINECTOMY PUNCH**



Forward 90° Regular Footplate

	2 mm bite forward	
	11-064-00	150 mm
	11-065-00	200 mm

	3 mm bite forward	
	11-066-00	150 mm
	11-067-00	200 mm

	4 mm bite forward	
	11-068-00	150 mm
	11-069-00	200 mm

	5 mm bite forward	
	11-070-00	150 mm
	11-071-00	200 mm

	6 mm bite forward	
	11-072-00	150 mm
	11-073-00	200 mm



Up 40° Regular footplate

	2 mm bite up	
	11-074-00	150 mm
	11-075-00	200 mm

	3 mm bite up	
	11-076-00	150 mm
	11-077-00	200 mm

	4 mm bite up	
	11-078-00	150 mm
	11-079-00	200 mm

	5 mm bite up	
	11-080-00	150 mm
	11-081-00	200 mm

	6 mm bite up	
	11-082-00	200 mm

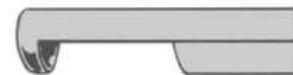

Down 90° Regular footplate

	3 mm bite down	
	11-083-00	150 mm
	11-084-00	200 mm

	4 mm bite down	
	11-085-00	150 mm
	11-086-00	200 mm

	5 mm bite down	
	11-087-00	150 mm
	11-088-00	200 mm



**THIN FOOTPLATE
KERRISON PUNCH**



Forward 90° Thin footplate

□	1 mm bite forward	
	11-089-00	150 mm
	11-090-00	180 mm
	11-091-00	200 mm
□	2 mm bite forward	
	11-092-00	150 mm
	11-093-00	180 mm
	11-094-00	200 mm
□	3 mm bite forward	
	11-095-00	150 mm
	11-096-00	180 mm
	11-097-00	200 mm
□	4 mm bite forward	
	11-098-00	150 mm
	11-099-00	180 mm
	11-100-00	200 mm
□	5 mm bite forward	
	11-101-00	150 mm
	11-102-00	180 mm
	11-103-00	200 mm



Up 40° Thin footplate

□	1 mm bite up	
	11-104-00	180 mm
□	2 mm bite up	
	11-105-00	180 mm
□	3 mm bite up	
	11-106-00	180 mm
□	4 mm bite up	
	11-107-00	180 mm
□	5 mm bite up	
	11-108-00	180 mm



Down 90° Thin footplate

□	1 mm bite down	
	11-109-00	180 mm
□	2 mm bite down	
	11-110-00	180 mm
□	3 mm bite down	
	11-111-00	180 mm
□	4 mm bite down	
	11-112-00	180 mm
□	5 mm bite down	
	11-113-00	180 mm

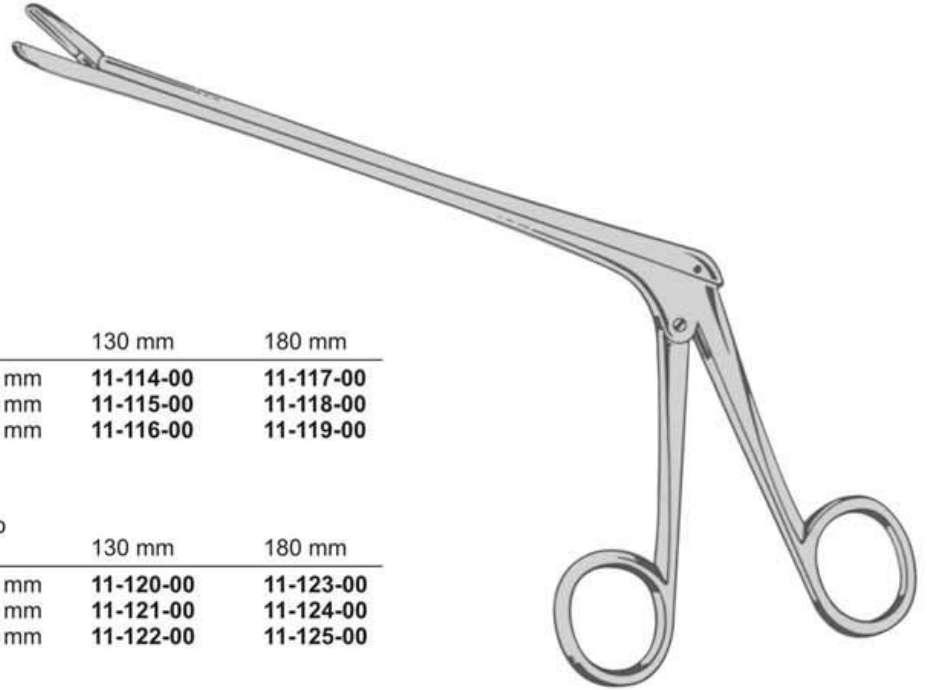
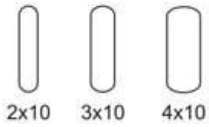

**CUSHING
LOVE - GRUENWALD
SPURLING**

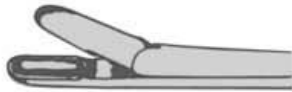

Straight Shaft	130 mm	180 mm
Bite 2 x 10 mm	11-114-00	11-117-00
Bite 3 x 10 mm	11-115-00	11-118-00
Bite 4 x 10 mm	11-116-00	11-119-00



Angled - up Shaft	130 mm	180 mm
Bite 2 x 10 mm	11-120-00	11-123-00
Bite 3 x 10 mm	11-121-00	11-124-00
Bite 4 x 10 mm	11-122-00	11-125-00



Angled - down Shaft	130 mm	180 mm
Bite 2 x 10 mm	11-126-00	11-129-00
Bite 3 x 10 mm	11-127-00	11-130-00
Bite 4 x 10 mm	11-128-00	11-131-00

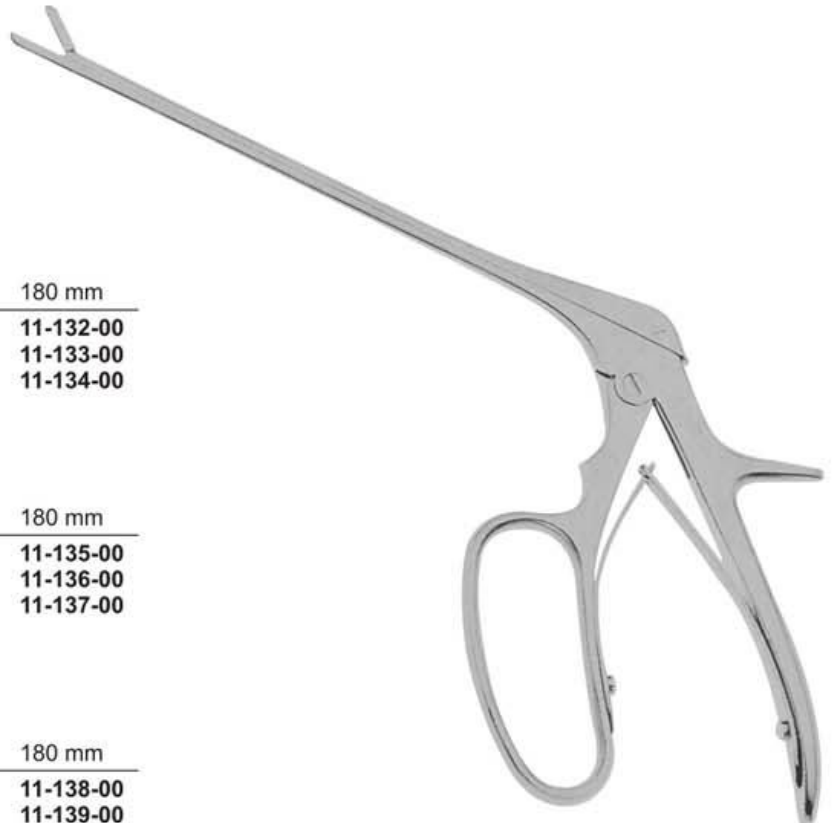
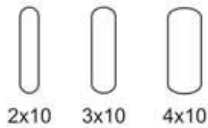

FERRIS - SMITH

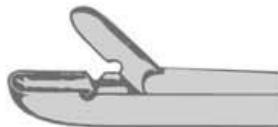

Straight Shaft	180 mm
Bite 2 x 10 mm	11-132-00
Bite 3 x 10 mm	11-133-00
Bite 4 x 10 mm	11-134-00



Angled - up Shaft	180 mm
Bite 2 x 10 mm	11-135-00
Bite 3 x 10 mm	11-136-00
Bite 4 x 10 mm	11-137-00



Angled - down Shaft	180 mm
Bite 2 x 10 mm	11-138-00
Bite 3 x 10 mm	11-139-00
Bite 4 x 10 mm	11-140-00

4 mm 5 mm 6 mm

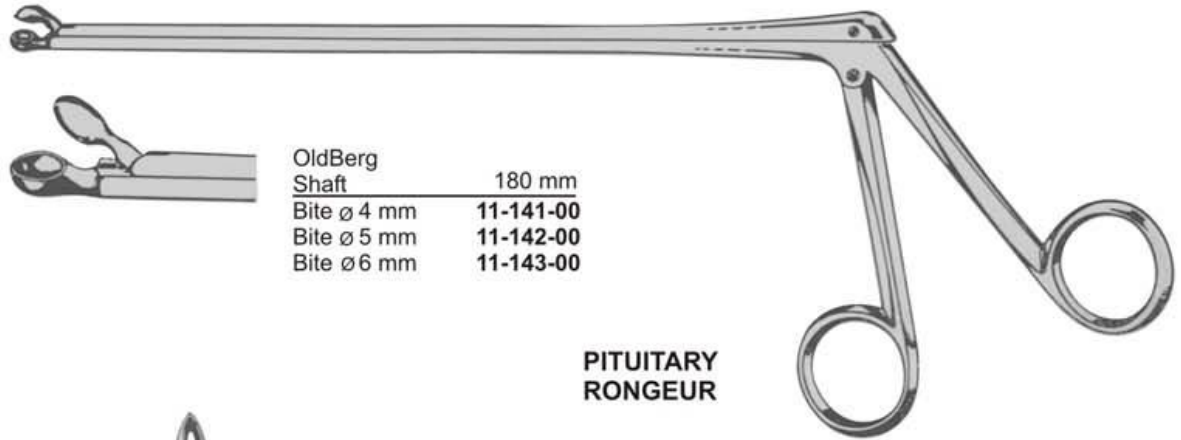

11-144-00 3.0 mm 11-145-00 3.6 mm 11-146-00 4.2 mm
11-147-00 4.8 mm 11-148-00 5.8 mm

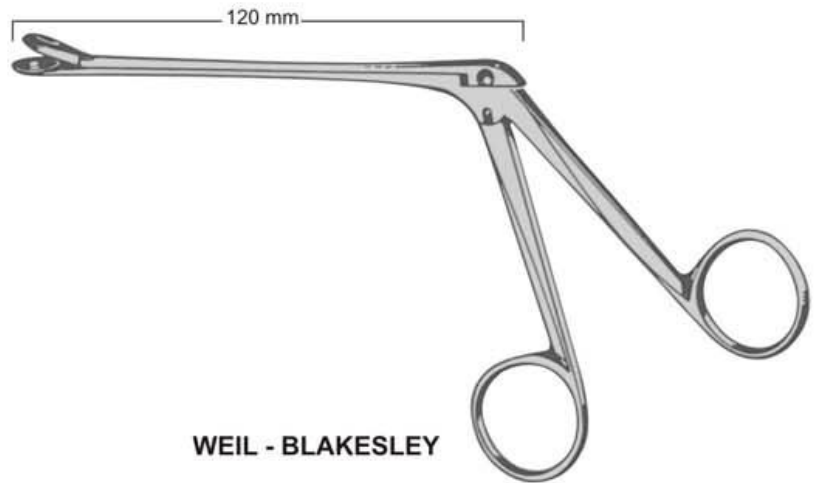

11-149-125 small 4 x 9 mm bite 11-150-125 Medium 5 x 10 mm bite 11-151-125 large 6 x 11 mm bite

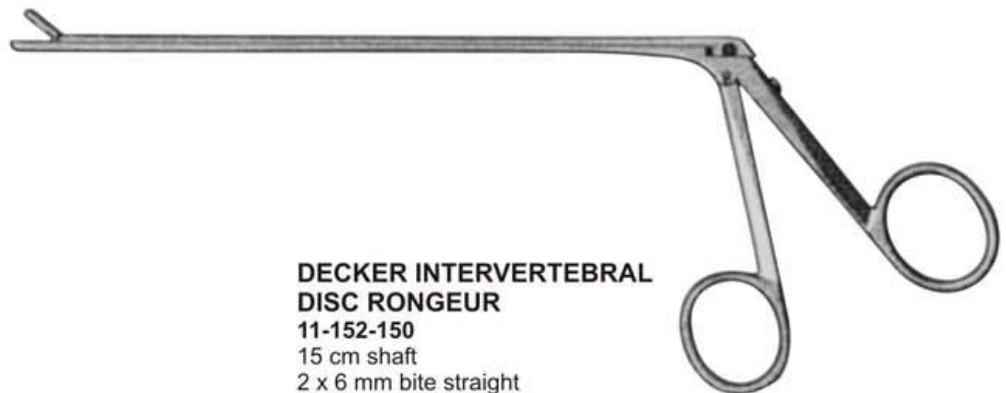
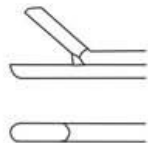

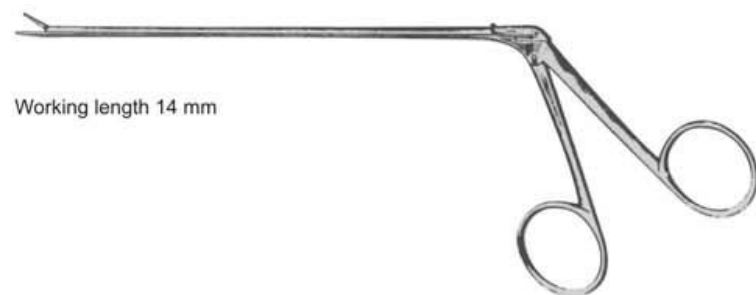

Working length 14 mm

**MICRO GRASPING
FORCEPS**
11-153-00
serrated, straight



**MICRO ALLIGATOR
SCISSORS**
11-154-00
straight



11-155-00
Ø1.0 mm
Straight



11-156-00
Ø2.0 mm
Straight



11-157-00
Ø3.0 mm
Straight

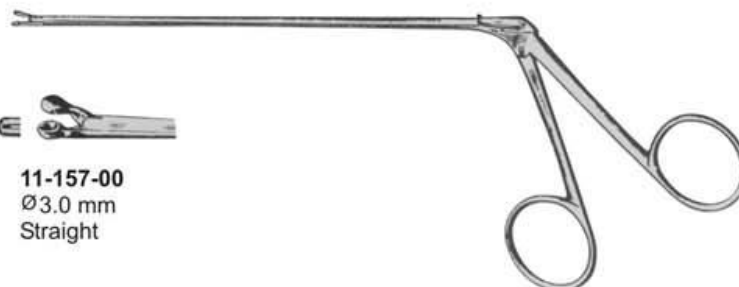

**MIRCO CUP
FORCEPS**



11-158-00
Ø1.0 mm
angled up



11-159-00
Ø2.0 mm
curved to right



11-160-00
Ø3.0 mm
curved to left



11-161-180
Grasping Forceps
Ø 3 mm



11-162-180
Cup Forceps
Ø 2 mm



11-163-180
Alligator Scissors
Ø 2 mm



**MICRO ALLIGATOR
FORCEPS**
with tubular shaft 18 cm

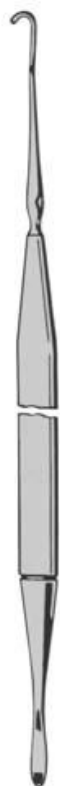

SCOVILLE
11-164-300
30 cm
Nerve Hook and
Dissector



SCOVILLE
11-165-300
30 cm
Nerve Hook and
Dissector



SCOVILLE
11-166-300
30 cm
Sympathectomy Hook
and Dissector



11-167-190
Davis
4 mm, 19 cm



11-168-200
Sachs
3 mm, 20 cm



11-169-200
Sachs
6 mm, 20 cm

NERVE SEPARATOR & SPATULA



FRAZIER
11-170-125
12.5 cm



GILLIES
19 cm



11-171-190
Small



11-172-190
large



11-173-130
Straight
13 cm



LAHEY CLINIC
11-174-130
13 cm



SACHS
11-175-185
18.5 cm



11-176-160
16 cm



TOENNIS
11-177-150
15 cm



**DURA
TWIST HOOK**
11-178-140 14 cm



1/2

RANEY
11-179-160
16 cm



1/4

RANEY
11-180-00



1/2

11-181-180
18 cm
Straight



1/2

11-182-200
20 cm
Straight

Penfield



1/2

11-183-200
20 cm
Straight



1/2

11-184-220
22 cm
Straight

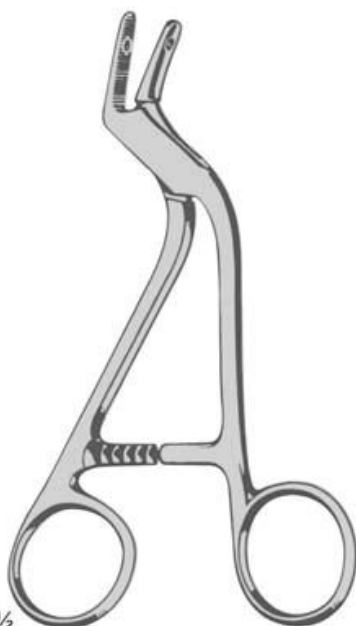

1/2

ADSON
11-185-150
15 cm
Drill Guide and
Dura Protector

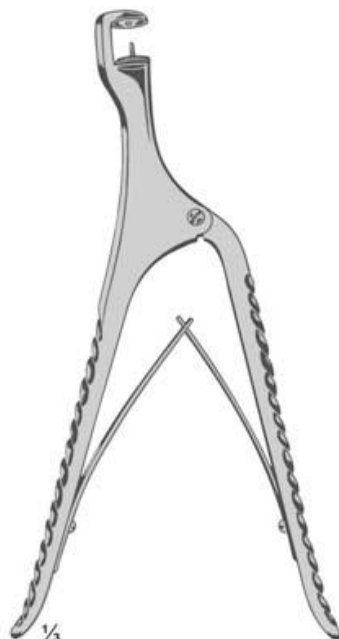

1/3

11-186-00
11-187-00
20 cm
23 cm
Skull Punch



1/3

DAHLGREN
11-188-200
20 cm
Complete with 2 Blades

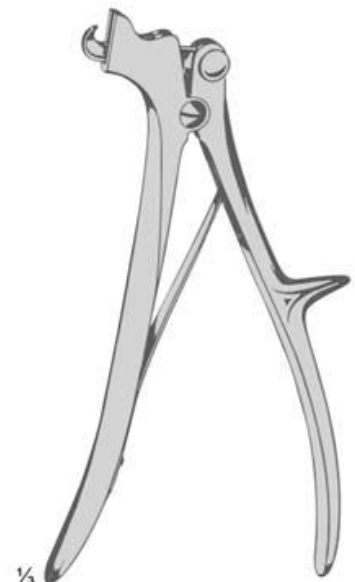

1/3

DEVIBISS
11-189-210
21 cm
complete with 1 small and
1 large blade



INGE
11-190-160
16 cm
Small pattern

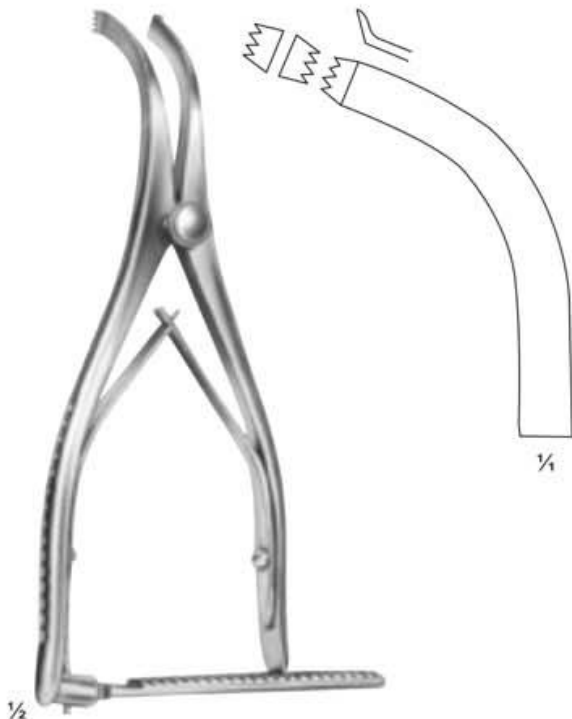

INGE
11-191-170
17 cm



INGE, 26 cm
11-192-260 Jaw width 5 mm
11-193-260 Jaw width 10 mm
large pattern



CLOWARD
11-194-130
13 cm



LUMBAR LAMINA SPREADER
11-195-00
arm length: 87.5 mm
spread: 37.5 mm



CLOWARD
11-196-160
16 cm



11-197-140
14 cm

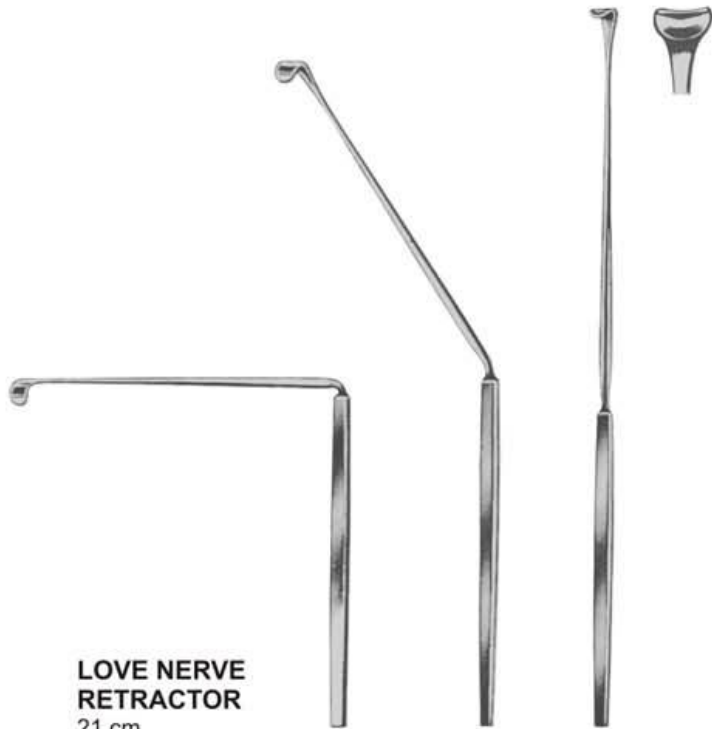

LOVE NERVE RETRACTOR

21 cm
7 mm width x 5 mm depth

- 11-198-210 Straight blade
- 11-199-210 blade angled 45° degrees
- 11-200-210 blade angled 90° degrees

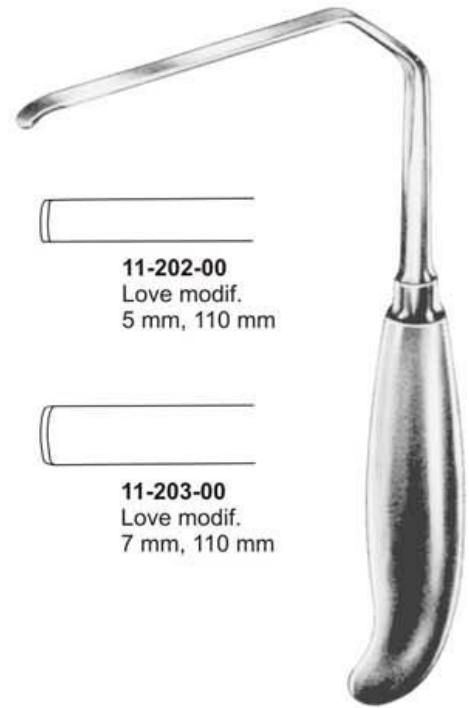

11-202-00
Love modif.
5 mm, 110 mm

11-203-00
Love modif.
7 mm, 110 mm

LOVE MODIF.
11-201-00
4 mm, 100 mm



HOLSHER NERVE RETRACTOR

- 11-204-230 23 cm angled 7 mm blade
- 11-205-230 9 mm blade

NERVE ROOT RETRACTOR

- 11-206-00 6 mm blade
- 11-207-00 9 mm blade
Offset 225 mm

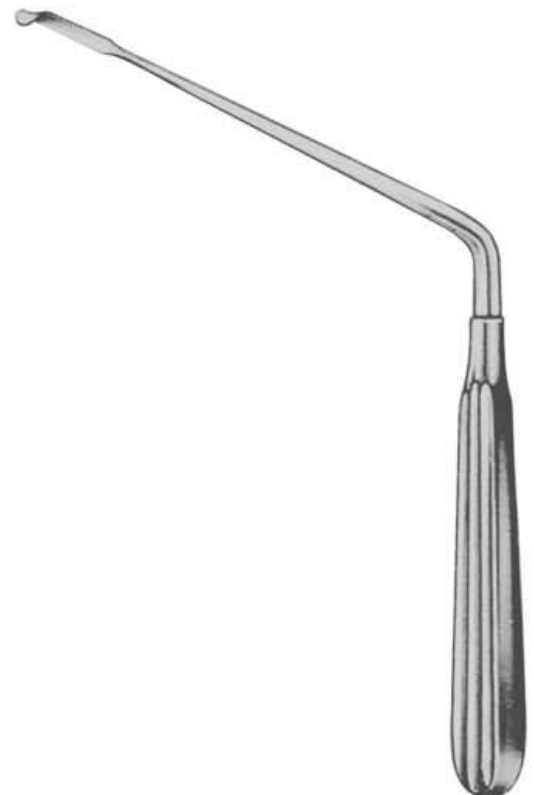

SCOVILLE NERVE ROOT RETRACTOR

- 11-208-230 8 mm blade
- 11-209-230 13 mm blade
23 cm angled