

SECTION - 15

UROLOGY





COLLIN
15-001-265
26.5 cm



DARTIGUES
15-002-270
27 cm



COLLIN
15-003-285
28.5 cm



HULKA-KENWICK
Uterine Elevating &
Manipulating Forceps
15-004-273
27.3 cm



RANDALL

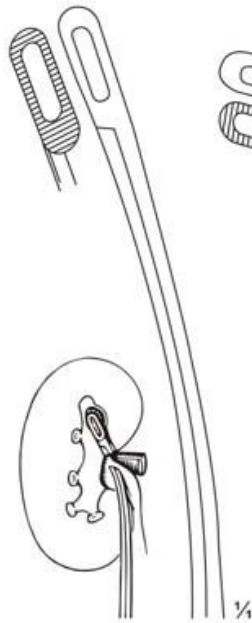

15-005-230
23 cm

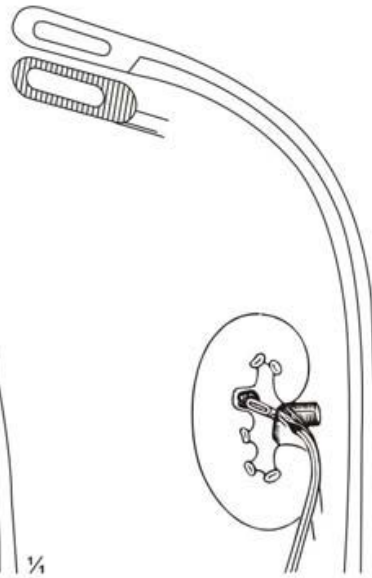

15-006-230
23 cm

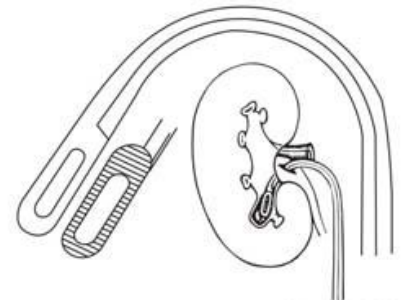

15-007-230
23 cm

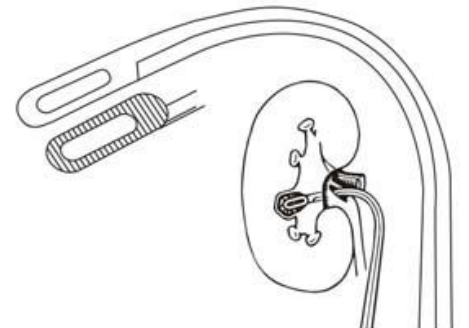

15-008-230
23 cm

11 x 50 mm

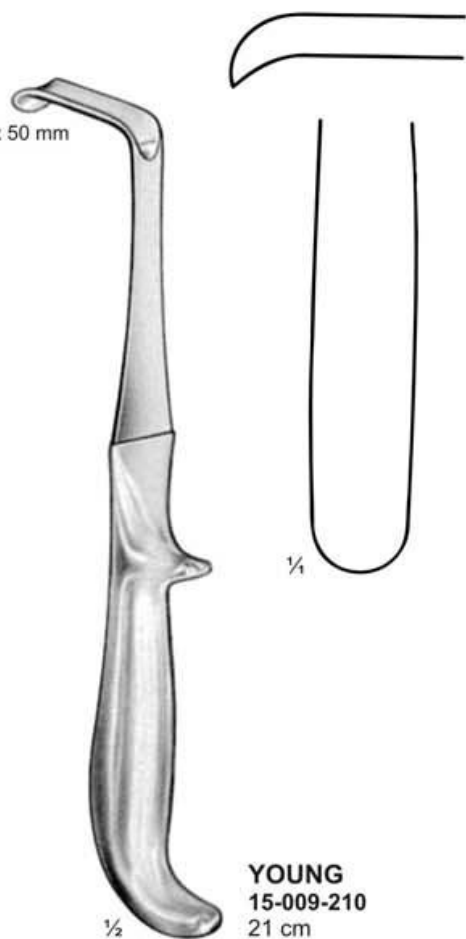

YOUNG
15-009-210
21 cm

38 x 64 mm

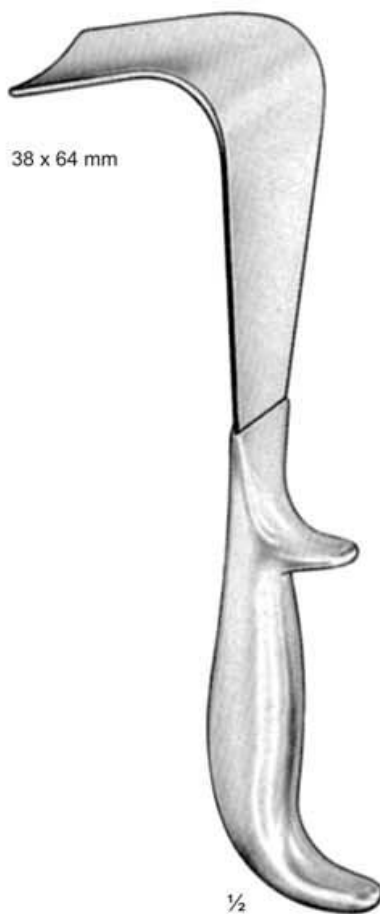

YOUNG
15-010-220
22 cm

25 x 25 mm

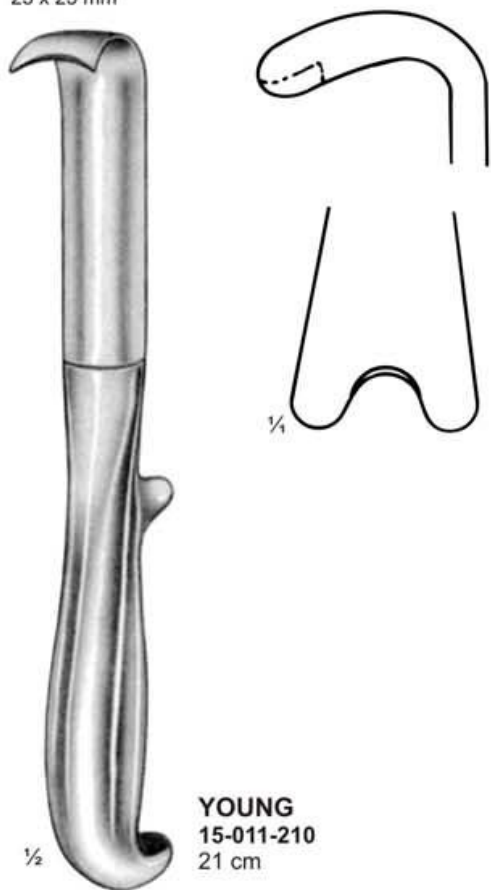

YOUNG
15-011-210
21 cm

39 x 35 mm



YOUNG
15-012-220
22 cm

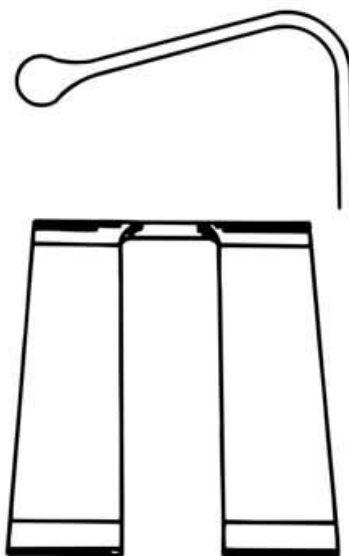
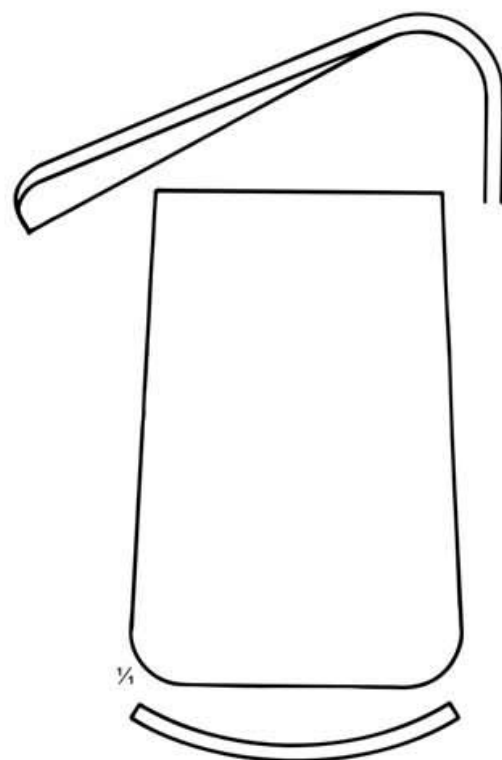

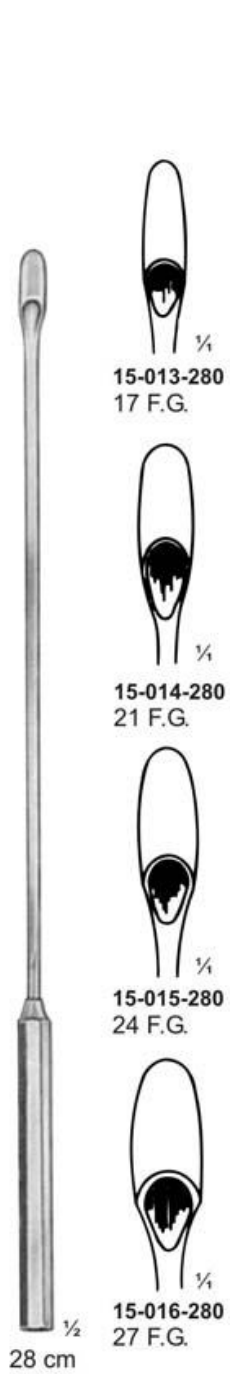

15-013-280
17 F.G.

15-014-280
21 F.G.

15-015-280
24 F.G.

15-016-280
27 F.G.

28 cm



MOYNIHAN
15-017-340
34.0 cm



15-019-280
13 F.G.

15-020-280
18 F.G.

15-021-280
21 F.G.

DESJARDINS
15-018-280
28.0 cm



BAKES
15-022-300
Set of 13
30.0 cm



Fig. 1
15-023-300

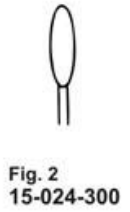

Fig. 2
15-024-300

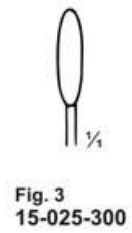

Fig. 3
15-025-300

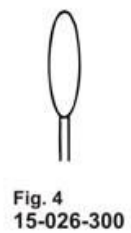

Fig. 4
15-026-300

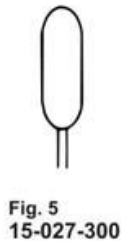

Fig. 5
15-027-300

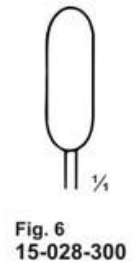

Fig. 6
15-028-300



Fig. 7
15-029-300

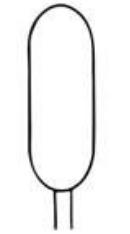

Fig. 8
15-030-300

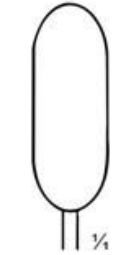

Fig. 9
15-031-300

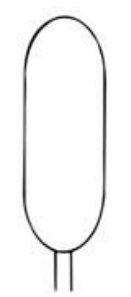

Fig. 10
15-032-300



Fig. 11
15-033-300



Fig. 12
15-034-300



Fig. 13
15-035-300



CATHETER
15-036-265
26.5 cm
14 Fr



CATHETERS
15-037-290 29 cm
Male Catheters, metal

	French
15-038-01	8
15-039-02	10
15-040-03	12
15-041-04	14
15-042-05	16
15-043-06	18
15-044-07	20



LISTER BOUGIES
15-045-270
27 cm
00 / 1 to 15 / 18
set of 17



CLUTTON BOUGIES
15-046-270
27 cm
06 / 10 to 28 / 32
set of 12



VAN BUREN
A TO O
Set of 15

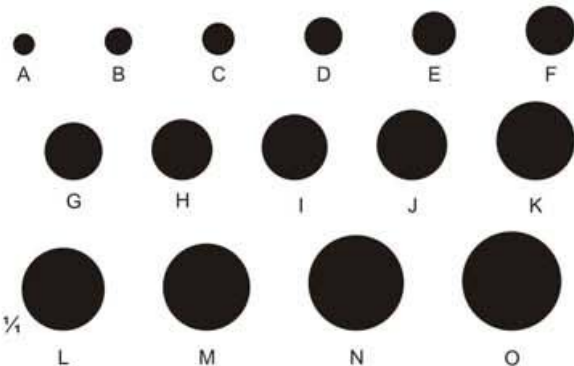
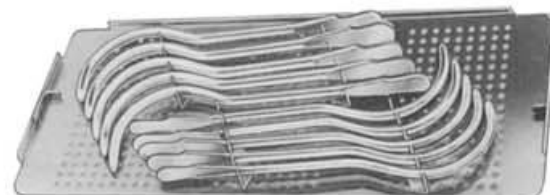
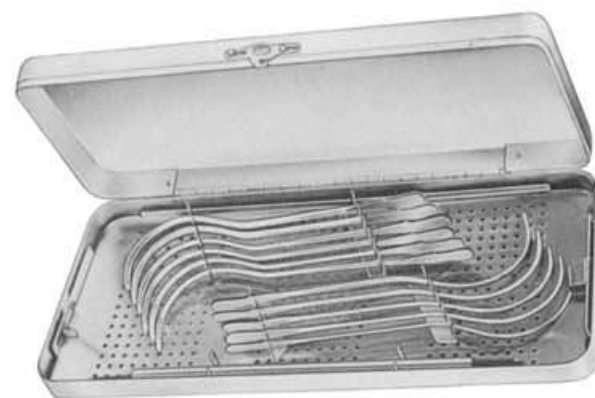

Fig.	Item	Description	Dia.
A	15-047-280	28 cm	8 French
B	15-048-280	28 cm	10 French
C	15-049-280	28 cm	12 French
D	15-050-280	28 cm	14 French
E	15-051-280	28 cm	16 French
F	15-052-280	28 cm	18 French
G	15-053-280	28 cm	20 French
H	15-054-280	28 cm	22 French
I	15-055-280	28 cm	24 French
J	15-056-280	28 cm	26 French
K	15-057-280	28 cm	28 French
L	15-058-280	28 cm	30 French
M	15-059-280	28 cm	32 French
N	15-060-280	28 cm	34 French
O	15-061-280	28 cm	36 French



GUYON
15-062-270
27 cm

Without thread



GUYON
15-063-00
420 x 175 x 40 mm
Set in metal case containing:
— 21 Bougies Guyon
— 6 filiform Bougies

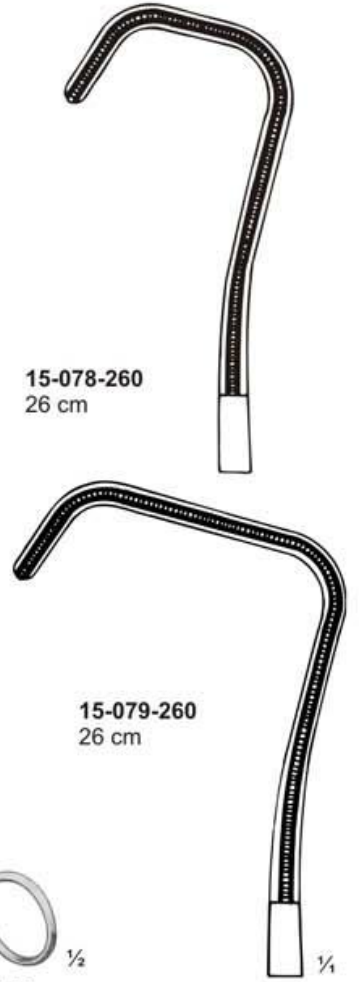
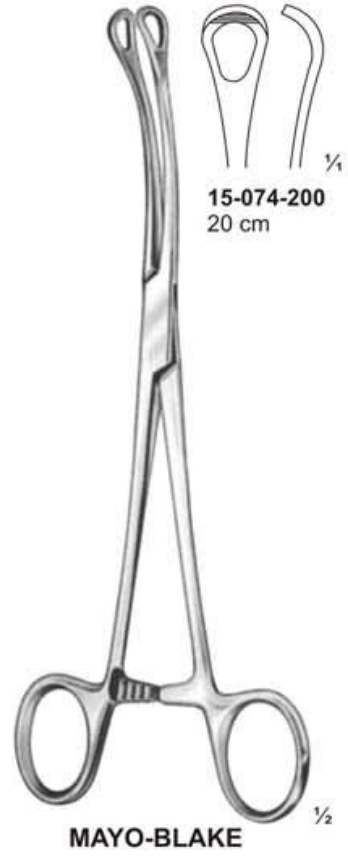
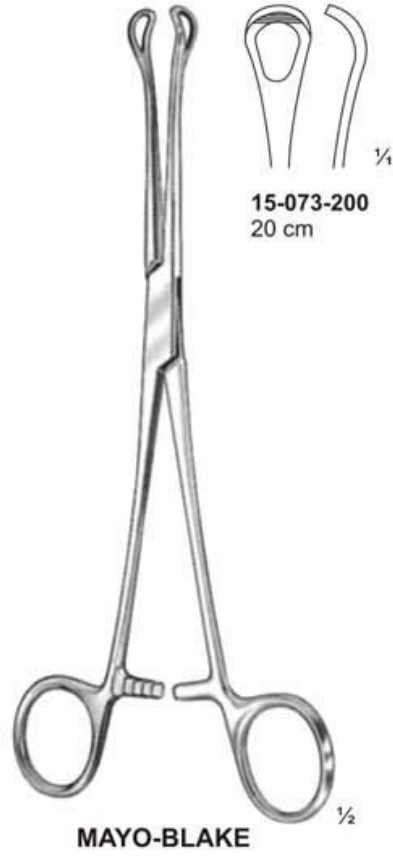
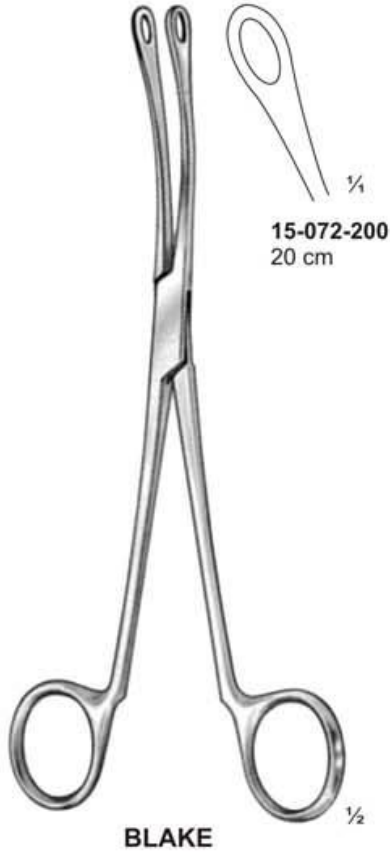
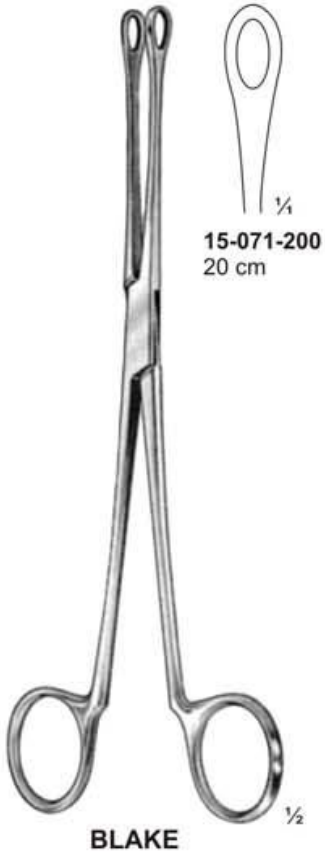

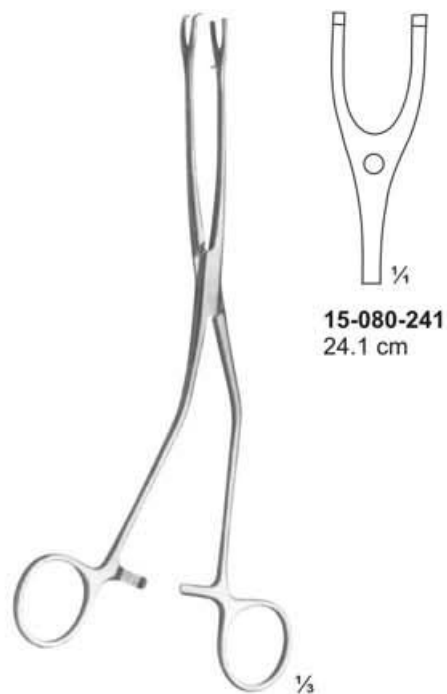

15-080-241
24.1 cm

HARRIS
Angled Suture



15-081-292
29.2 cm

JOHNSON PROSTATIC
NEEDLE HOLDER

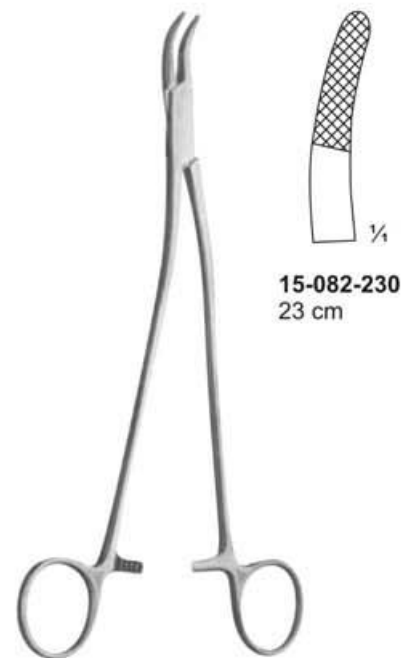

15-082-230
23 cm

STRATTE NEEDLE HOLDER

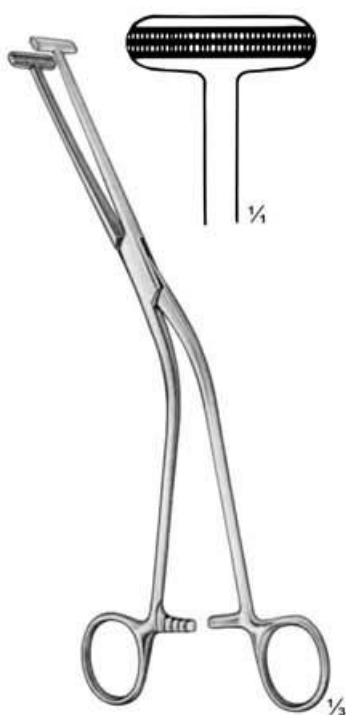

MILLIN
15-083-240
24 cm



MILLIN
15-084-230
23 cm



MILLIN
15-085-230
23 cm



MILLIN
15-086-230
23 cm

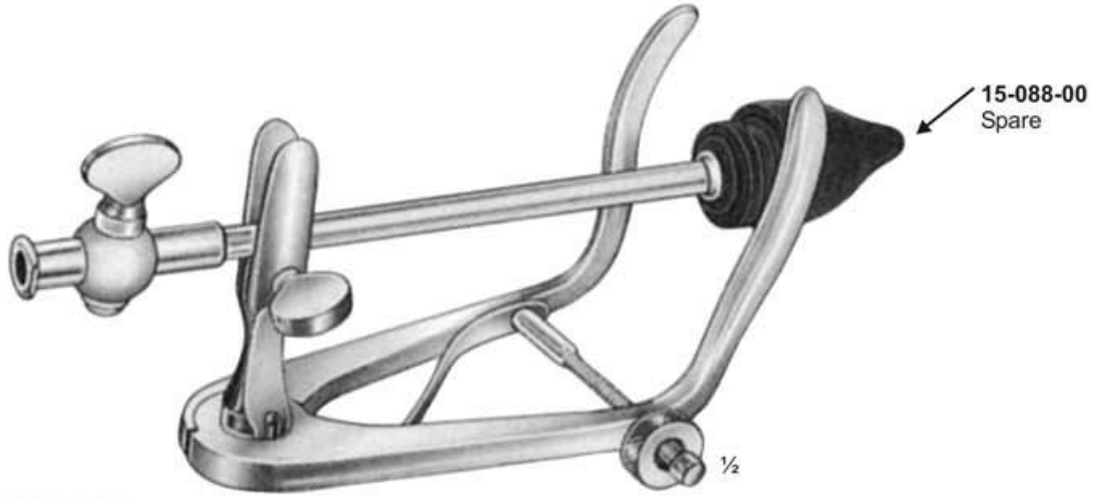

KNUTSON
15-087-180
18 cm
Urethrographie-Instruments

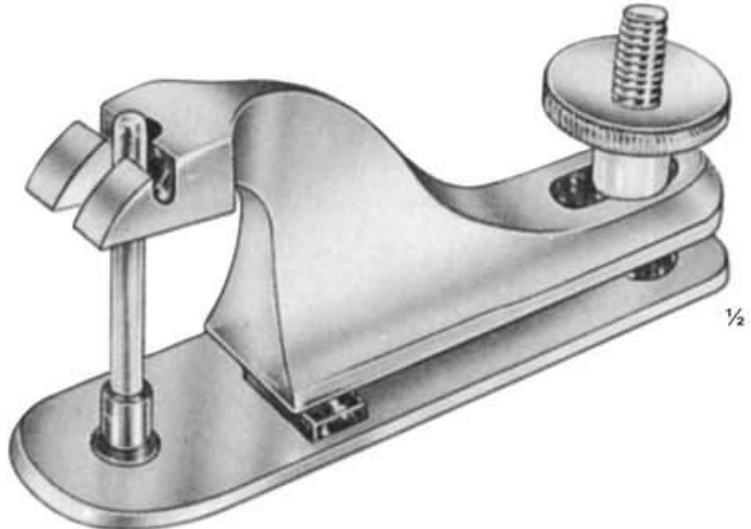

- mm ø
- 8 15-089-00
 - 11 15-090-00
 - 13 15-091-00
 - 16 15-092-00
 - 21 15-093-00
 - 26 15-094-00
 - 32 15-095-00

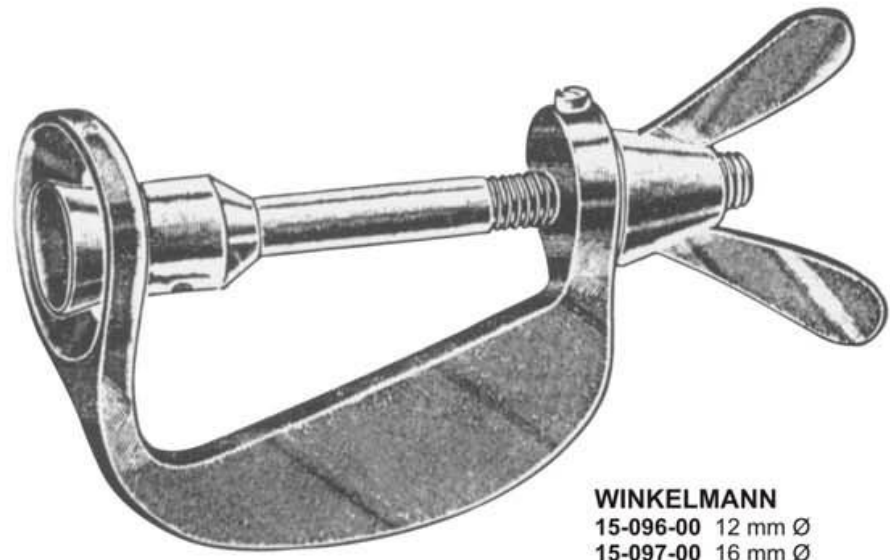

WINKELMANN
15-096-00 12 mm Ø
15-097-00 16 mm Ø
15-098-00 20 mm Ø
Circumcision clamps



MILLIN
15-099-280
28 cm

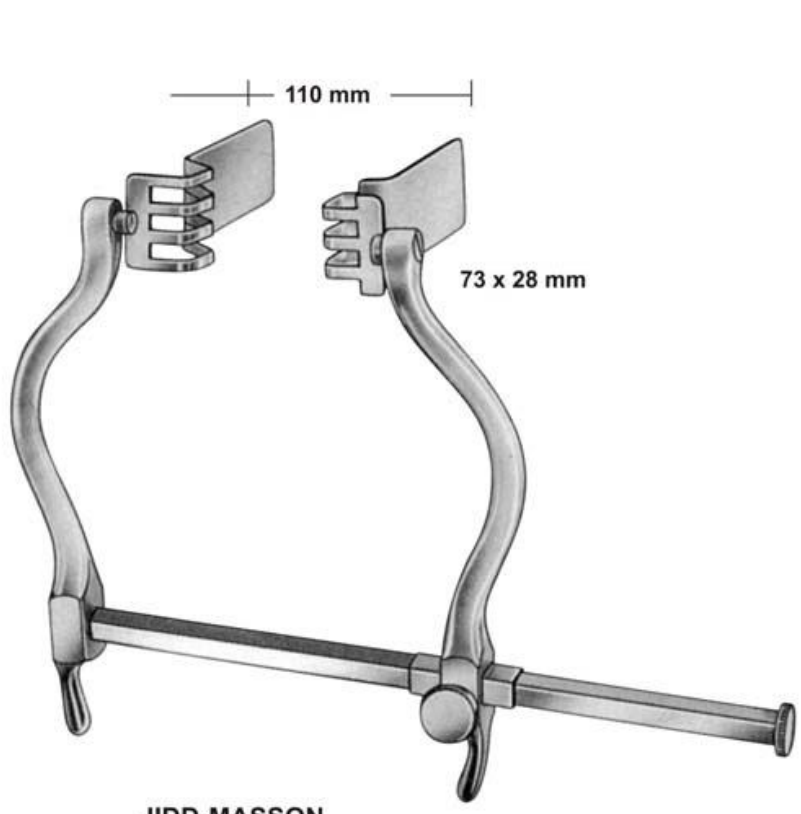

JIDD-MASSON
15-100-00

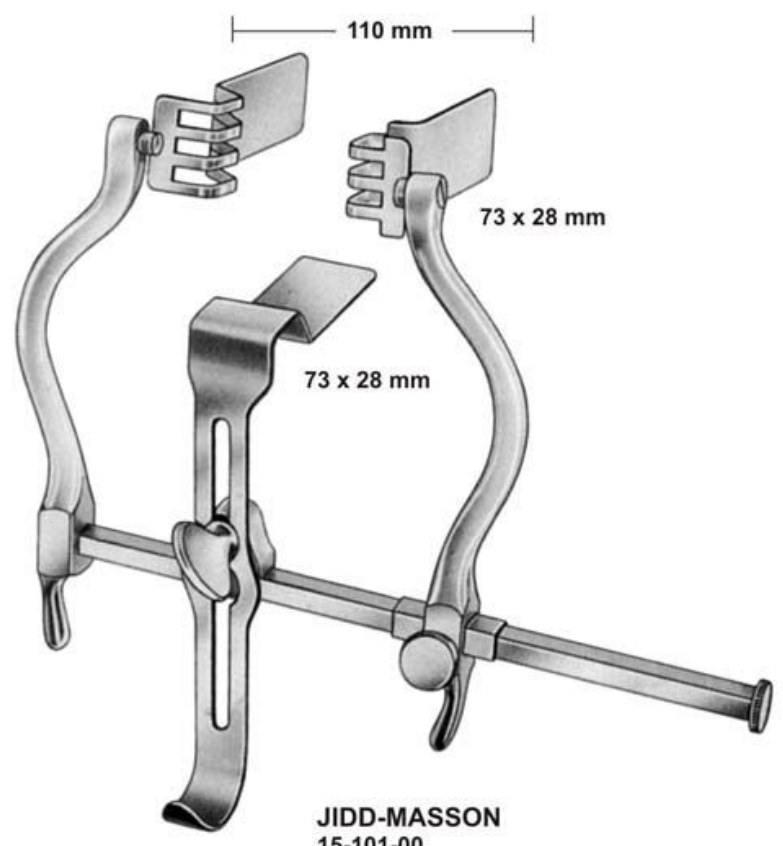

JIDD-MASSON
15-101-00

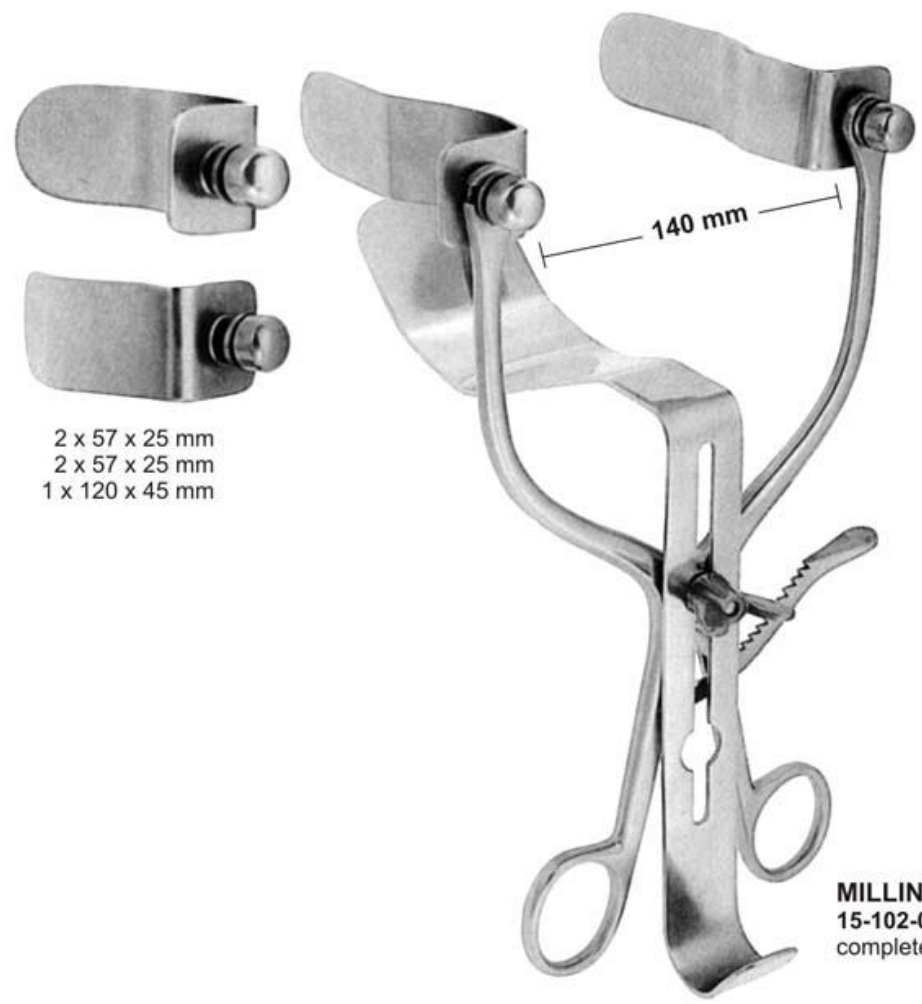

MILLIN
15-102-00
complete



LEGUEU
15-103-170
17 cm